

PRODUCTS

2020



SERIES

A - H

ACCESS 27-49

A completely new storage line and desks with the focus on function and choice.



EMBRACE 103-105

A sound absorbing floor screen with Soundfelt that divides and encloses.



ARC 53-55

A solid wooden stool with a characteristically Nordic design.



EVE 111-115

A wide series of office chairs available in a range of equipment options.



CLAIR 59-63

A neat and elegant sofa that blurs the boundary between private and public spaces.

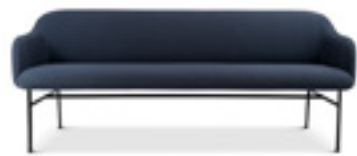

FEATHER 117-127

Versatile and adaptable chairs and tables designed with elegance to fit many different environments.



CONE 67-71

A pedestal that combines easily with all types of chairs and is built to last.



GATHER 129-133

A modular sofa series that enables an endless number of combinations.



EASE 81-101

Versatile dividers and screens to create a room within the room.



HUG 135-139

A light chair composed for comfort, accessibility and function.



SERIES

L - X

LOOP 141-143

A comfortable stool designed for public environments and to cope with a great deal of wear.



RESOLVE 217-221

Sofa and armchair with generous widths, made for undisturbed conversations.



NEAT 145-179

Storage units and desks with an airy, streamlined appearance for modern offices.



RESOLVE PLAY 223-227

A playful and characterful sofa that connects with Velcro.



OPUS 185-187

A Sit 'n' Stand desk that offer less choices and the same high and dependable quality.



SOLID 233-237

A solid wood table top produced in full stave with a groove on the underside that offers a comfortable grip.



PART 189-195

A room-dividing storage system, with a back side as attractive as its front.



ZIV 239-243

A comfortable chair and sofa available with a number of different frames.



PIECE 197-214

Designed for creative work & meetings.



X-PRESS 13-23

A selection of our most popular furniture for the work space, ready for delivery within five days.



”

Edsbyn has been around for 120 years, the secret of our success is the ability to change. The goal with the project #rethinkwork is to find newthinking answers for a functional and pleasant workplace in the future.
- Bengt Gunnarsson CEO, Edsbyn.



#RETHINKWORK



No.

Edsbyn does not intend to guess what the next-gen workplace looks like.

We will find out.

An office revolution is ongoing. Digitalization questions the norm of how and where work is done, the need at the physical environment changes. It's time to stop, ask the right questions and dare to listen. This project is the starting point for a deep and honest analysis of the workplace, run by Edsbyn in collaboration with Superlab. The analysis starts in Edsbyn's interactive booth, at Stockholm Furniture Fair 2020, Conceptualized by Superlab and Designed by Jens Fager. Are you curious about the future workplace? Welcome to join us on this journey!

[Instagram.com/edsbyn](https://www.instagram.com/edsbyn) #rethinkwork

ARC STOOL

DESIGN JENS FAGER



When Jens Fager was granted the honor of designing a stool for the Swedish National Museum, he enlisted the help of the Edsbyn woodshop.

Arc Stool was born – A solid wooden stool with a characteristically Nordic design. The elegant lines and curves of the seat are borrowed right from the Swedish National Museum's Nordic architectural style. The masterfully turned legs and foot rest lend the stool its finer details, reflecting Jens Fager's deep respect for the wood.

"A solid wooden stool that will stand the test of time, not just in the halls of the new Swedish National Museum but in many rooms the world over"

Design Jens Fager

NEW

CLAIR CAFÉ SOFA

DESIGN ANDREAS ENGESVIK, OSLO



A neat and elegant sofa that blurs the boundary between private and public spaces with its soft lines and practical functions. With a higher seat height, the Clair Café Sofa is ideal for cafés, restaurants, libraries, and waiting rooms. The straight outer contours make it easy to place in a room, and allow several sofas to be combined back to back as well as side by side.

Clair Café Sofa is designed with a tasteful "crumb gap" that keeps the furniture piece fresh and easy to clean.

Design Andreas Engesvik, Oslo

PIECE SERVE

DESIGN TEA



A stylish recessed holder that fits as an accessory to the Piece Table and are easily placed in the cut-out for the cable management.

Piece Serve creates an impression on the room, it is waterproof and the content can be varied according to the occasion. The drainage with a cover plug makes it easy to keep clean.

The holder is made of sheet metal and is available in the same standard colors as we offer Piece Table legs; White, Black, Misty Grey and Dark Chocolate.

"Piece Serve can be used as a storage tray by day, an ice bucket for your evening celebration or even as a pot for fresh herbs to add that finishing touch to your lunch meeting"

Design TEA

NEAT GREEN NET

DESIGN TEA

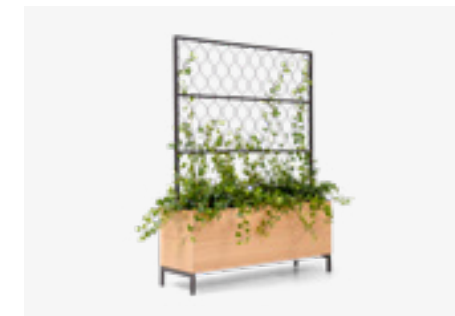

This decorative trellis is a complement for the Neat Green flower box. The medallion-shaped net is ideal for climbing plants and make the trellis a room divider where you decide on the transparency with your choice of plants.

Neat Green Net is made of steel and is available in the range of three widths 800, 1200 and 1600 mm. Choose from the colors Black, White, Misty Grey and Dark Chocolate. The trellis is inserted directly into a mount in Neat Green, the floor-standing flower box.

"Aesthetics, Function and Character that evoke historical references. The soft medallion-shapes give a beautiful contrast to the otherwise streamlined design of the Neat series "

Design TEA



X-PRESS

When getting started is more than urgent.

The X-Press range contains a selection of our most popular furniture for the work space.

Ready for delivery within five days.





PERSONAL LOCKER (Left)

White Laminate
(W 800 mm, H 3x44, D 432 mm)

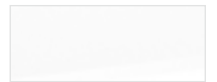

Handles

Access Grip, Design Andreas Engesvik
White Lacquer

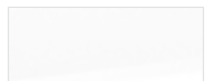

Details

Plinth
Grey

Lock
Edsbyn Standard with key

Item ID: 68UB3EXP



ACCESS STORAGE

With the focus on Function & Choice.
Edsbyn has been producing quality customised furniture for over 100 years.

The Access Series is our response to new demands
to fit the next generations workspace.



TECHNICAL SPECIFICATION

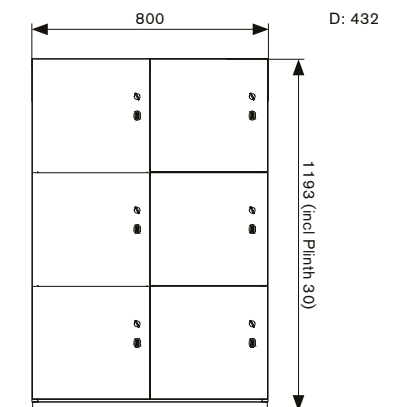

ACCESS TOWER



BY EDSBYN

ACCESS STORAGE



BY EDSBYN



RIGHT

White Laminate
(W 435 mm, H 3xA4, D 800mm)

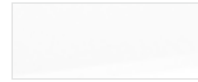

Details

Handle
Access Grip, Design Andreas Engesvik, White Lacquer

Pen tray
Tidy Tray, By Edsbyn, Grey.

Item ID: 68TA3EXP



SLIDING DOORS

White Laminate
(W 1180 mm, H 3xA4, D 416 mm)

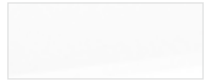

Handles

Access Grip, Design Andreas Engesvik
White Lacquer

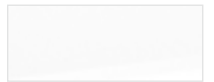

Details

Plinth
Grey

Lock
Edsbyn Standard with key

Item ID: 68HC3EXP



LEFT

White Lacquer
(W 435 mm, H 3xA4, D 800mm)

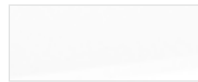

Details

Handle
Access Grip, Design Andreas Engesvik, White Lacquer

Pen tray
Tidy Tray, By Edsbyn, Grey.

Item ID: 68TA3EXP



TECHNICAL SPECIFICATION

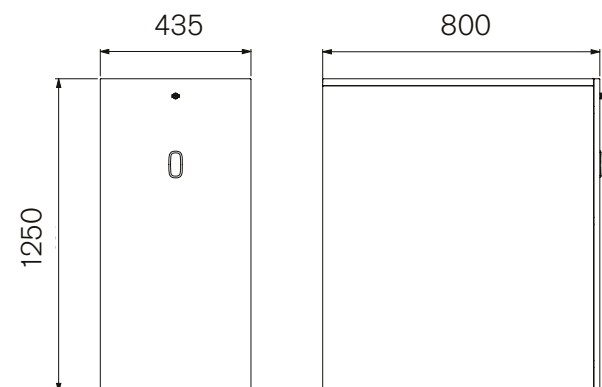

TECHNICAL SPECIFICATION

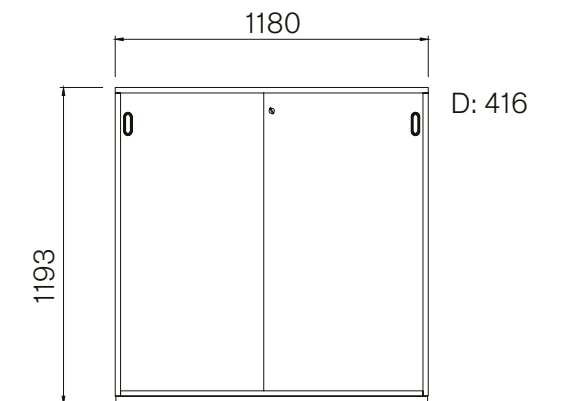

HUG CHAIR

DESIGN JENS FAGER



HUG CHAIR

This is a chair composed for comfort, accessibility and function. The challenge has been in working with the pressed veneer to achieve bold curves which are comfortable yet retain the clean lines and strength of the material.

Design Jens Fager



LACQUER LEGS

Black Lacquer

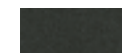

WOOD

White Glazed Ash



Item ID: 20693EXPF



LACQUER LEGS

Black Lacquer

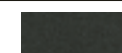

WOOD

Black Stained Oak



SOFT SEAT

Black Elmosoft Leather



Item ID: 20693EXPK



LACQUER LEGS

Black Lacquer

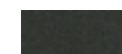

WOOD

Black Stained Oak



SOFT SEAT

Brown Elmosoft Leather



Item ID: 20693EXPK



MEASUREMENTS

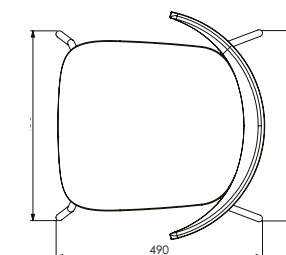
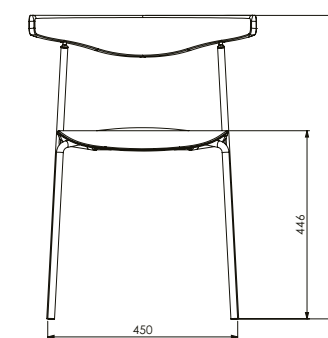
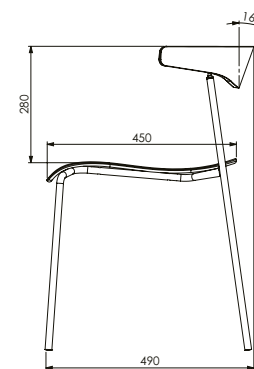
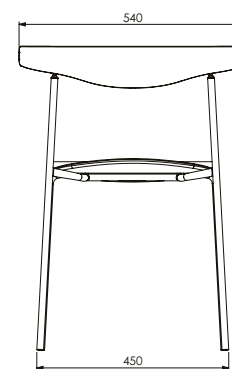

FEATHER CONFERENCE



DESIGN JENS FAGER



FEATHER CONFERENCE

Scandinavian simplicity at it's best.

Feather Conference Table is with advantage adaptable to different environments as offices, conference, restaurant, school and at home.

Design Jens Fager



DETAILS

Table Top
The table tops are manufactured as 19 mm MDF sheets with straight edges.

Stand
The table is available in 730 mm height (incl. table top). The feet is laser cut and welded in the stand.

LACQUER STAND

Black Lacquer



WOOD TABLE TOP

White Glazed Ash



Item ID: 44B12EXP



TECHNICAL SPECIFICATION

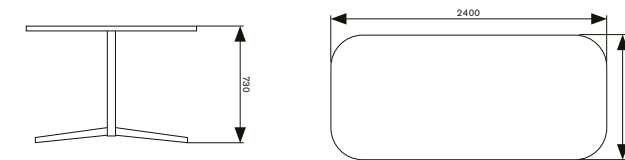

DETAILS

Table Top
The table tops are manufactured as 19 mm MDF sheets with straight edges.

Stand
The table is available in 730 mm height (incl. table top). The feet is laser cut and welded in the stand.

Power Box
PowerBox White. Equipping: 3 power, 2 network.

LACQUER STAND

Black Lacquer



WOOD TABLE TOP

White Glazed Ash



Item ID: 44B12EXP



TECHNICAL SPECIFICATION

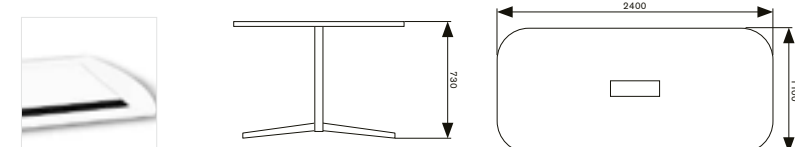



OPUS LIGHT

Vary between sitting and standing, or make just small adjustments to find your best working position.

Opus Light is constructed to cope with daily use in tough conditions and offer high stability, strong lifting force and a low noise level.



Electric Stand – Opus Light 2.0

White Lacquer
(Height 675-1175mm, excl tabletop)

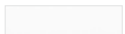

Item ID: 08404EXP



Table Top

White Laminate
(1400x800 mm)



Item ID: 56A11EXP2



Electric Stand – Opus Light 2.0

White Lacquer
(Height 675-1175mm, excl tabletop)

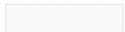

Item ID: 08404EXP



Table Top

White Laminate
(1600x800 mm)

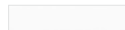

Item ID: 56A12EXP2



Table Screen Fabric

Camira Cara EJ 104
(1400x650x30 mm)



Item ID: 11548EXP14V

Camira Cara EJ 104
(1600x650x30 mm)



Item ID: 11548EXP16V



WIRE CABLE TRAY

White Lacquer
(490 mm)

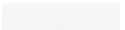

Item ID: 09677A025

TECHNICAL SPECIFICATION



Electric Stand
Beamless electrical stand with rectangular leg profile.

Push button:
Push button for height adjustment

Height intervals:
675-1175 mm, excl. table top.

Adjustable with:
1150-1740 mm.

Weight:
The electrical stand can accept approximately 100 kg of evenly distributed load (table top included).

MY EDSBYN

CONFIGURE YOUR EDSBYN PRODUCT & CREATE A QUOTE

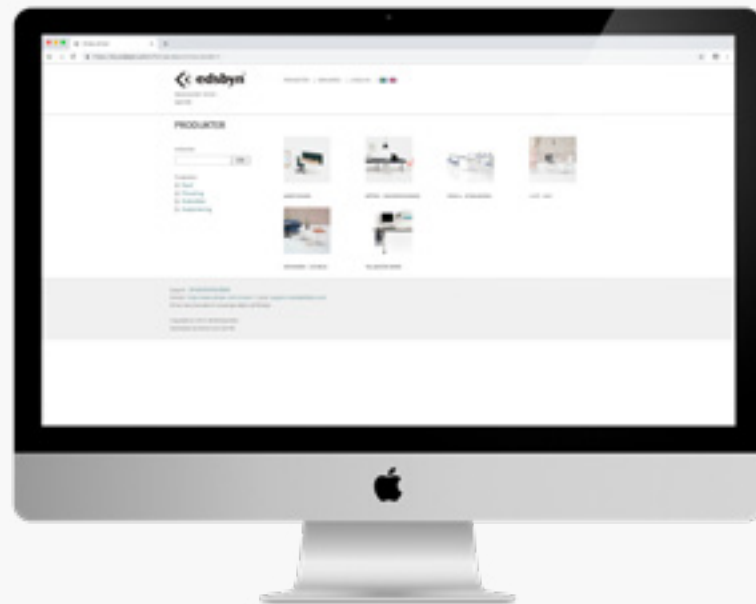

Configure colours and surface finishes of your products to create a quotation directly in My Edsbyn. When you get your quote you can automatically transform it to an order.

Send us an e-mail for your login details to My Edsbyn (my.edsbyn.com):
support.create@edsbyn.com

ORDER CONFIRMATION

Check your order confirmation within two working days. Any changes after this timeline will add an extra fee and your order will get a new delivery date.

DELIVERY TIMES (excl. transport)

Orders created in My Edsbyn are handled more quickly than other type of orders. Unless otherwise is agreed (usually follow the delivery time on next page)

PCON.PLANNER ME

CONFIGURE YOUR EDSBYN PRODUCT & CREATE 3D FLOOR PLANS



Create a 3D floor plan by configuring Edsbyn products directly in pCon.planner ME. Export your 3D room plan to quote in My Edsbyn.

Log in at My Edsbyn to download pCon.planner ME.

6 WORKING DAYS

Xpress – via My Edsbyn

20-30 WORKING DAYS

Standard via My Edsbyn

30-40 WORKING DAYS

Special via My Edsbyn / Standard via phone, mail etc.



ACCESS

With the focus on function and choice.

Edsbyn has been producing quality customised furniture for over 100 years, and the Access Family is our response to your demands.



ACCESS STORAGE

From simple elegance to individualized and exclusive, the choice is yours.

Access Storage is an entirely new storage series with the focus on function and flexibility. Configure the storage components to your own preference, fronts and carcasses are available in a broad selection of veneer as well as laminate and painted surfaces.

Access Storage is available with plinth or legs in several designs. Choose between an open storage system, rolling doors, sliding doors or classic swinging doors. Select the height, width and depth that you need. Select the standard model or a design option.



OPEN STORAGE

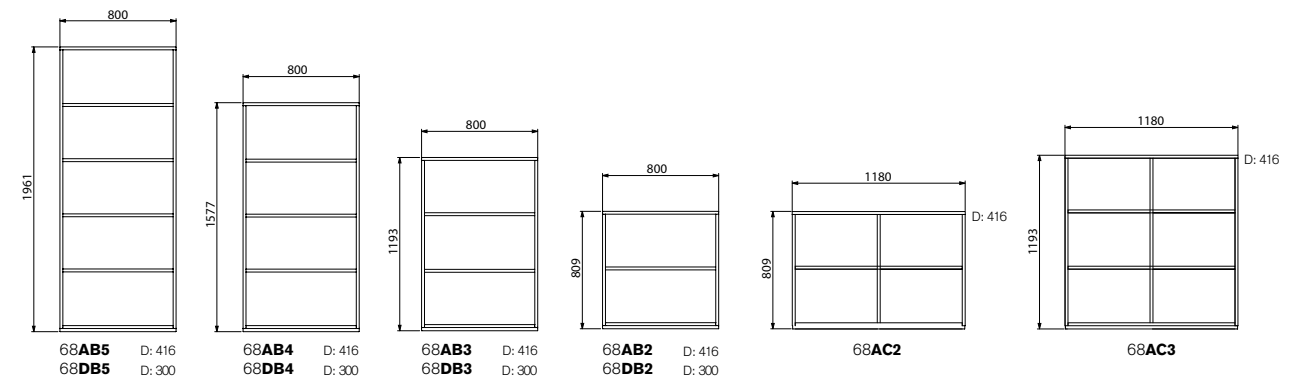

SWING DOORS

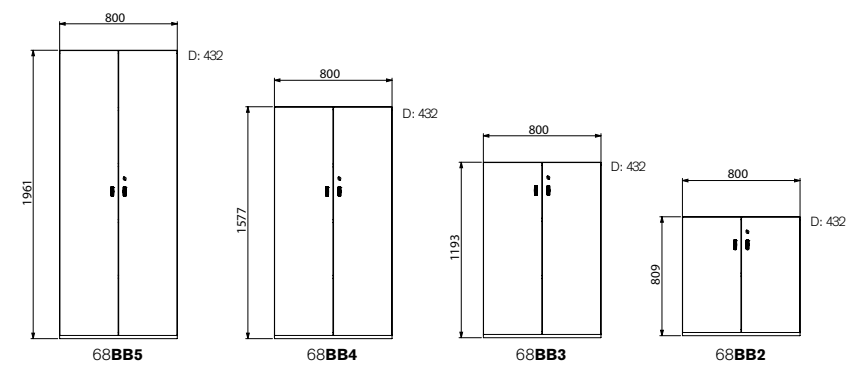

ROLL FRONT

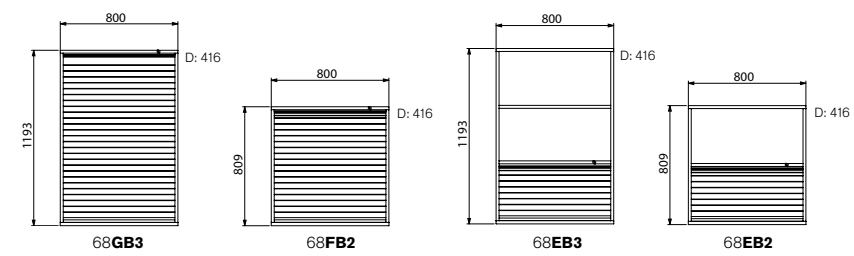

SLIDING DOORS

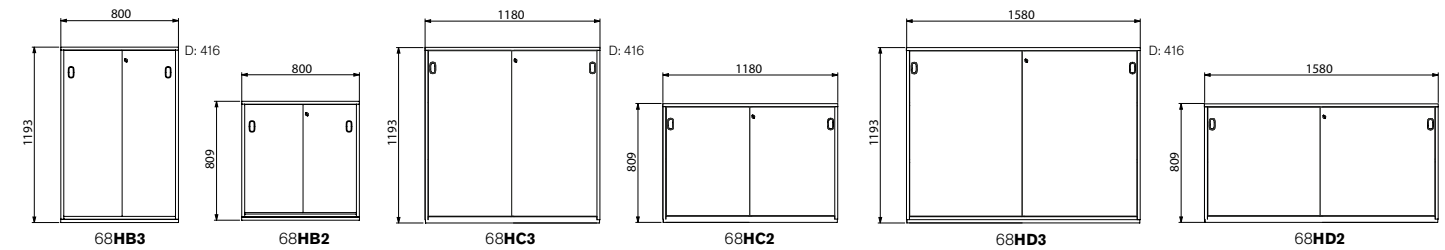

TOWER

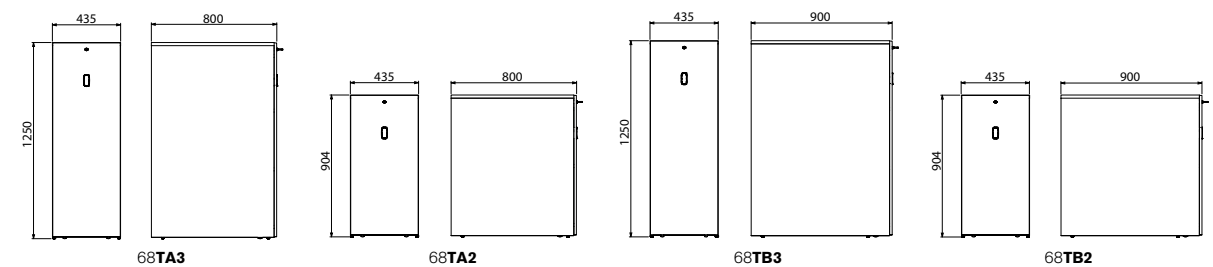

* Access storage in laminate



MATERIAL & COLOURS

Access Storage comes in a broad range of authentic veneers in Birch, Oak, Ash, laminate and with beautifully painted surfaces.

The Fern Green and Sandy Grey shades have been specially designed by Jens Fager. Fern Green was inspired by bracken and our serene Swedish forests. Sandy Grey conveys a sense of boulders crumbling into sand.

"Beautiful, subdued and serene"
//Jens Fager

UPPER UNITS

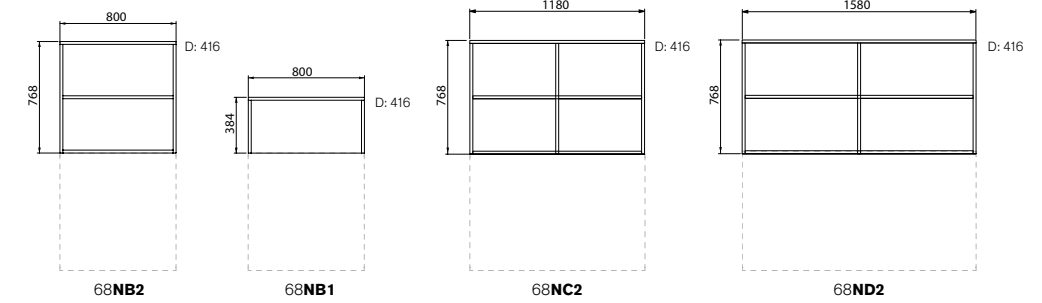

INCLINED UPPER UNITS

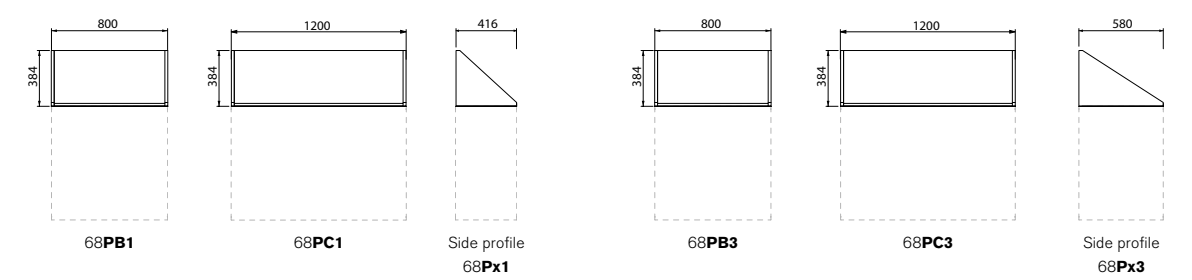

WARDROBES

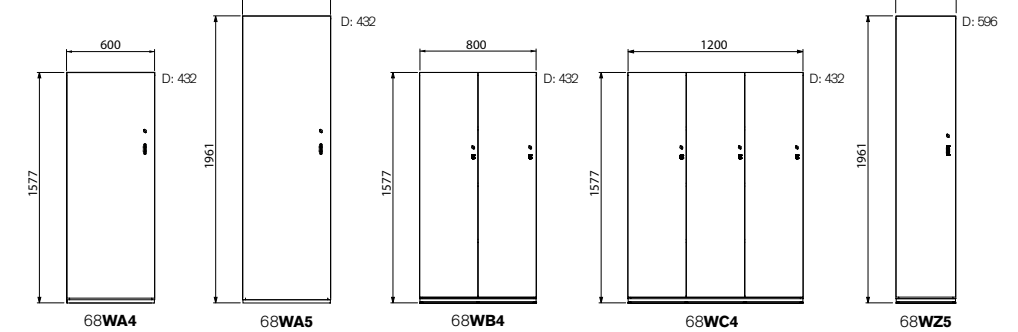

BENCH/SHOE STORAGE

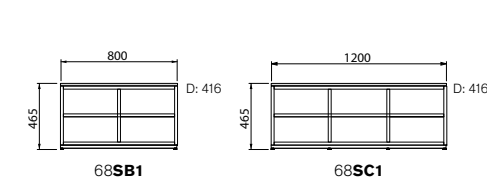

DRAWER UNITS

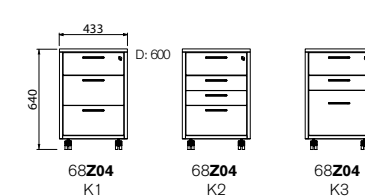

DRAWER INSERT

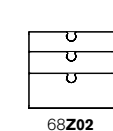

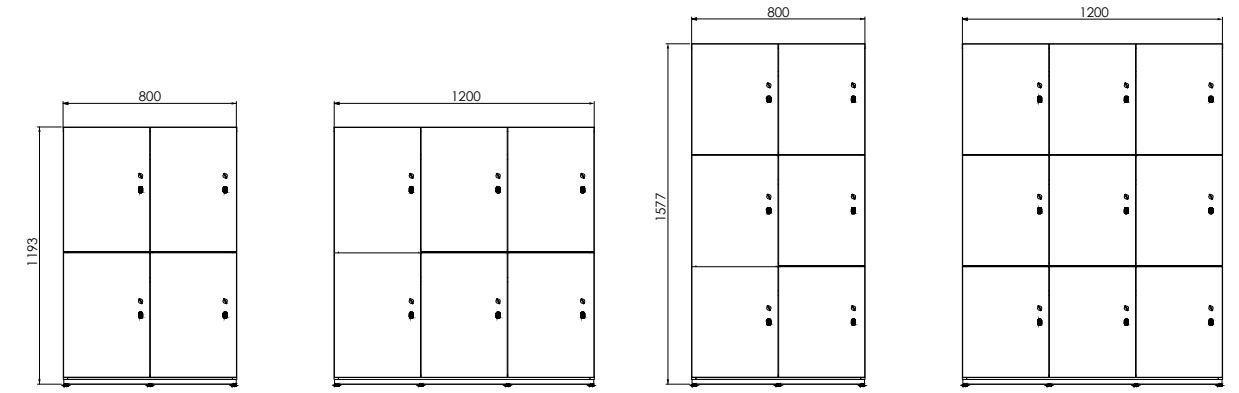
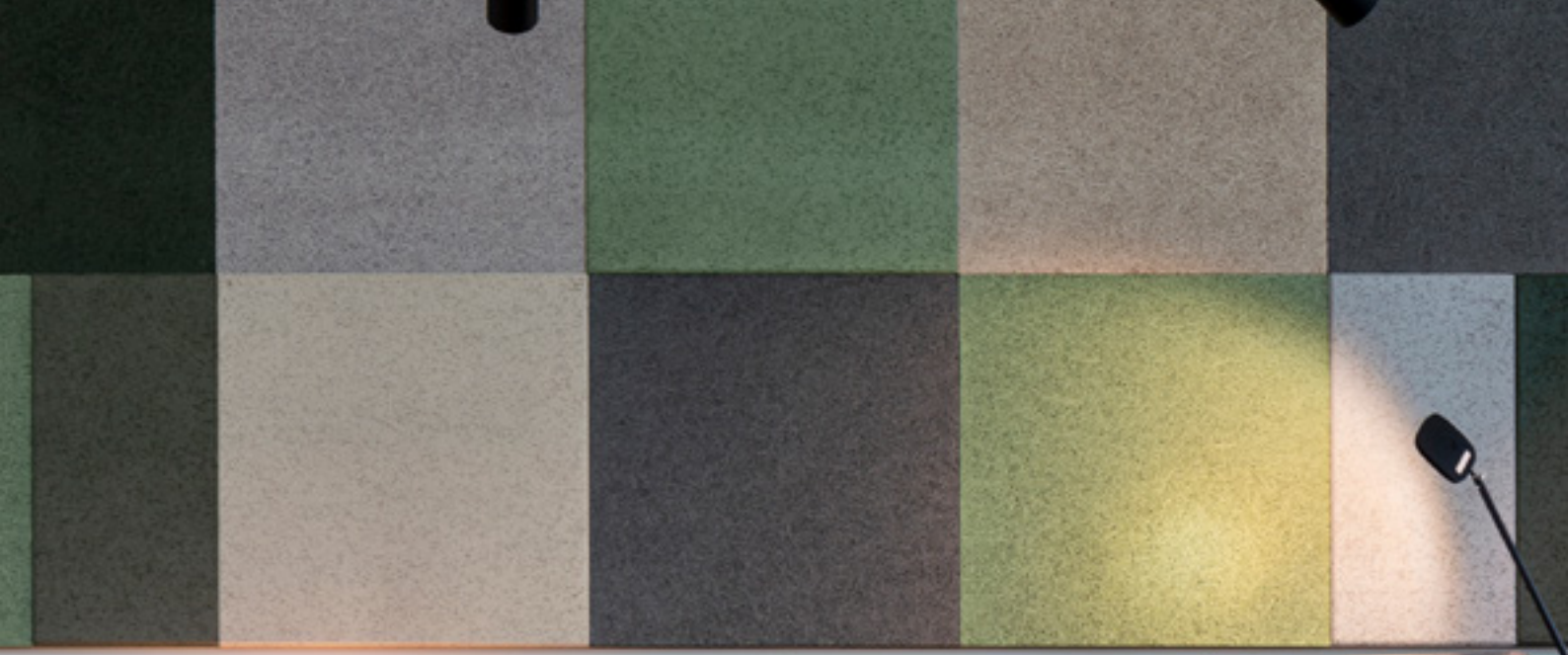

68JB3 D: 432
68KB3 D: 596
68JC3 D: 432
68KC3 D: 596
68JB4 D: 432
68KB4 D: 596
68JC4 D: 432
68KC4 D: 596

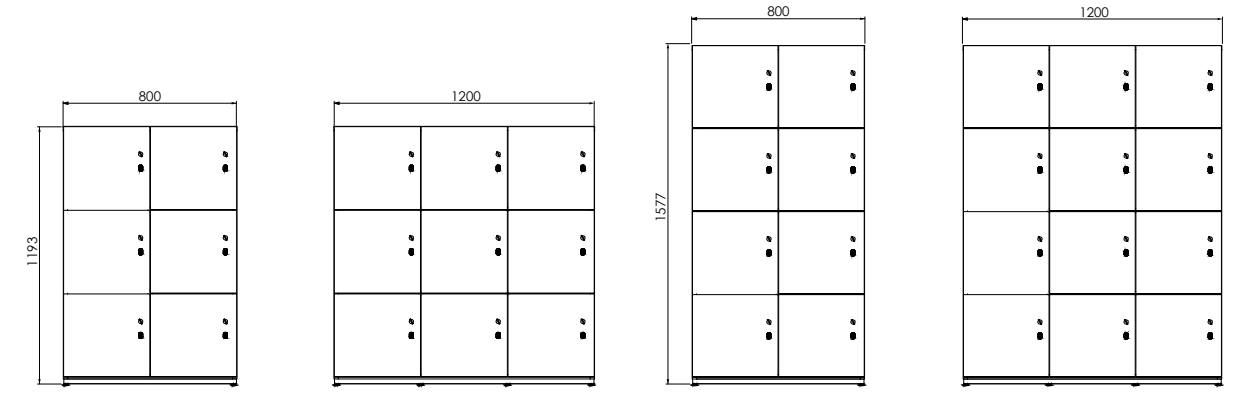

68UB3 D: 432
68XB3 D: 596
68UC3 D: 432
68XC3 D: 596
68UB4 D: 432
68XB4 D: 596
68UC4 D: 432
68XC4 D: 596

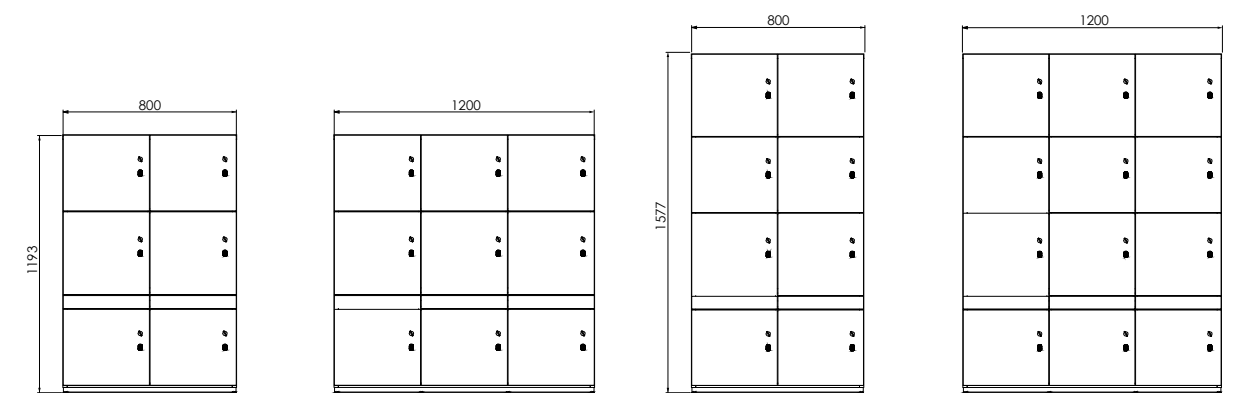

68VB3 D: 432
68YB3 D: 596
68VC3 D: 432
68YC3 D: 596
68VB4 D: 432
68YB4 D: 596
68VC4 D: 432
68YC4 D: 596

TECHNICAL SPECIFICATION

FRAME

Access Storage is constructed from 19 mm chipboard or MDF in veneer or topcoat. The veneer is 0.6 mm thick. Edge strip in wood or ABS. Backs in 3 mm or 6 mm MDF- or HDF-board.

FRONTS

Doors and fronts of the insert drawers etc. is constructed from 16 mm fibreboard or MDF sheet in veneer or topcoat. Edge strip in ABS. Some edges have open flat MDF edges.

A variety of locks and handles are available. Roll-front is constructed by 3 mm thick veneers and MDF sheet in veneer. Cotton fabric is used as carrier.

PLINTH

Sealed plinth, (height 30 mm), plinth version (height 30 mm), round tube legs or square pipe legs in metal. All plinths includes adjustable feet for uneven floors. Personal Locker is also available with high plinth (height 300 mm) – open and closed.

* Access storage in laminate



ACCESS GRIP

Cast handles with a tactile feel, shaped by the designer's own hands. Using a 1:1 scale, our designer, Andreas Engesvik, has handcrafted the mold for the Access Series most exclusive fittings made in cast aluminum.

"An expression made by the human hand for the human hand."

//Andreas Engesvik, Oslo





MODELS



Inset, small



Handle



Inset Large (Tower)



Nob



Inset Large (Sliding doors)

DETAILS

Design
Andreas Engesvik, Oslo

Cast handles with a tactile feel, shaped by the designer's own hands. Using a 1:1 scale, Andreas Engesvik, has handcrafted the mold for the Access Series most exclusive fittings.

Material
Cast Aluminium

Finish
Laquer

LACQUER

Black Lacquer



White Lacquer



Dark Chocolate



Aluminium



OPEN FILE BOX MAPPI A4

10678

On expansions, to be screwed on a shelf.
W 345, H 293, D 325.



ADJUSTABLE FILE BOX

(300-460 mm)

Without anti-tilt, adjustable width.
W 300-460, H 90, D 340.

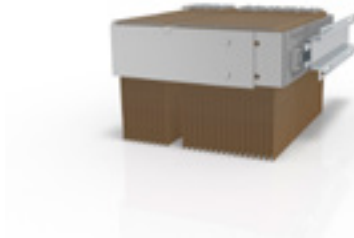

1067840040

ADJUSTABLE FILE BOX

(540-810 mm)

Without anti-tilt, adjustable width.
W 540-810, H 90, D 340.



TIDY TRAY

09Z01

Pen tray in plastic. 316x240 mm. Height 27 mm.



CLOTHES HOOK

10623

To mount on the gable of Access cabinet or shelf.



FILE SUPPORTING BOW

10626

Easy to mount on Access shelves to support files.
H 82, D 235.



INSERT

10Z04

Insert with compartments for open storage depth 396 mm or for closed storage depth 349 mm. W 340, H 340.



CASSETTE

1061470011

Including 7 crates. W 250, H 320, D 330. Black.



DRAWER INLAY FOR PEDESTALS

10604

Available with 5 compartments (for B-drawer), 7 compartments (for B-drawer) and as a single partition for drawers (W 330mm, H 72mm).



Code Lock



Standard Lock



Electric Lock

LOCKS

Code
4 digit Code Lock.

Standard
With Key.

Electric Lock EM (125 KHz) or Mifare (13,56 MHz)
Lock in open position by default (individual mode).



Wire Handle Square



Inset Handle Square

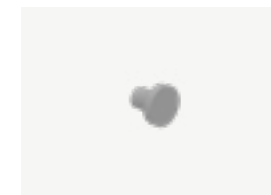

Nob Square



Leg Square



Wire Handle Round



Inset Handle Round

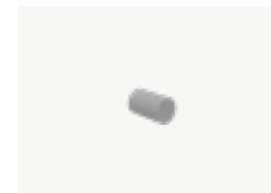

Nob Round



Leg Round



Wheel

HANDLE SQUARE & LEG SQUARE

Black Lacquer



White Lacquer



Silver Lacquer



HANDLE & LEG ROUND

Silver Lacquer

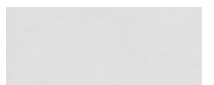

WHEELS

Silver Lacquer





ACCESS DESK

Access is a table series with strict, straight forms. The table tops are available in a number of different variants and many different colours and materials for tops and legs. This provides excellent opportunities to design functional, customer adapted workplaces.

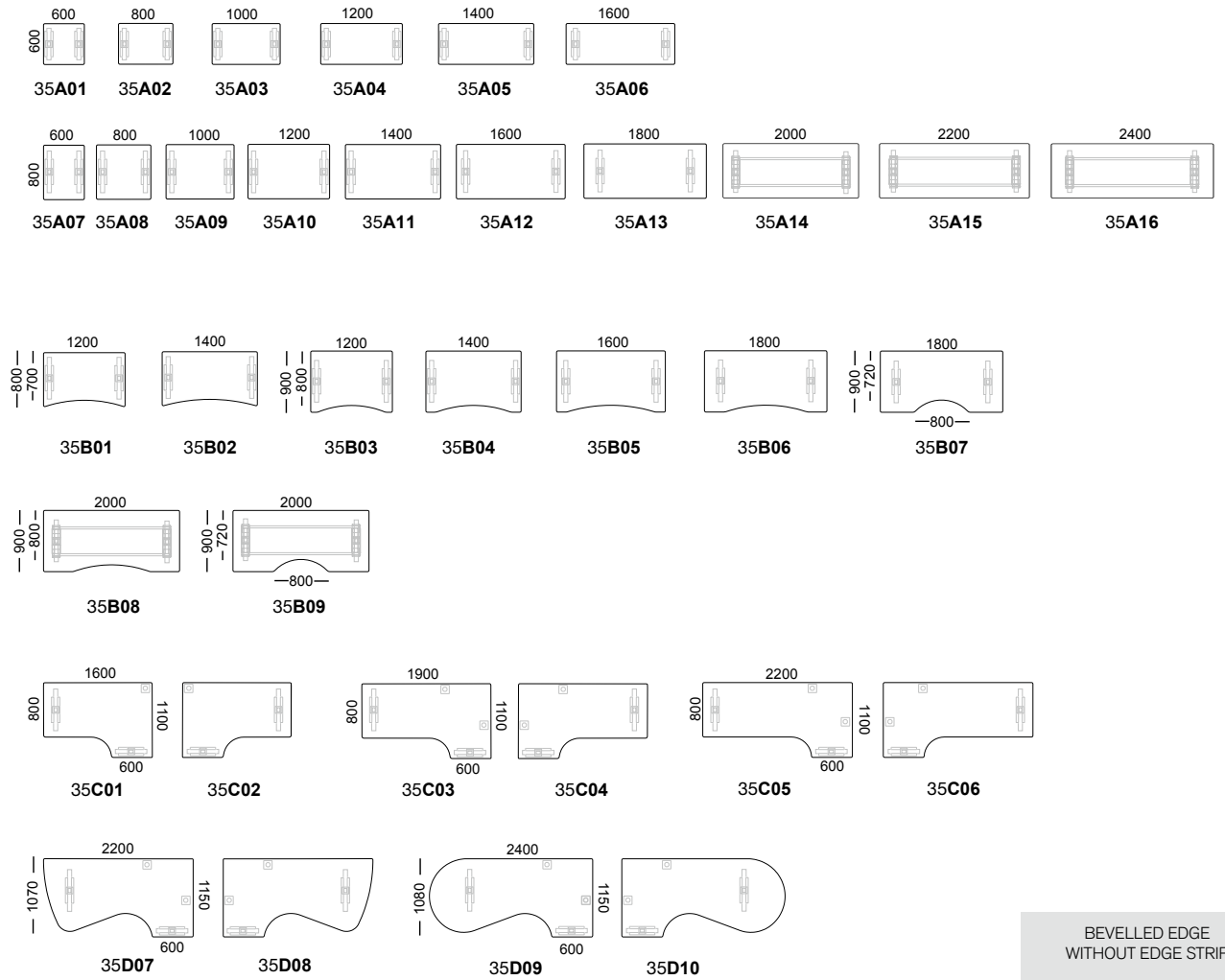

STANDS

Height adjustable
650-780 mm incl. Table Top.

2-Leg Stand
L 1600. D 800.

3-Leg Stand
L 1900. D 1100.



FEET

Varied Feet Length

Feet length vary according to deep of table top.

Adjustable Feet

Feet can be adjusted up to 10 mm to absorb irregularities in the floor.



For Table Top up to D 600



For Table Top up to D 800



Can be adjusted up to 10 mm

TECHNICAL SPECIFICATION

TABLE TOPS

Table tops that consist of 22 mm MDF which is available with a number of different surface materials, such as veneer or high-pressure laminate. The veneer is 0.6 mm thick and the high-pressure laminate 0.7 mm. Tables with a high-pressure laminate surface also have a barrier laminate on the underside.

EDGE PROFILE

Bevelled edge without edge strip. Bevelled open clear lacquered MDF edges. Radius 20 mm at corners. Standard surface material veneer or high-pressure laminate.

Straight edge. Straight edge strip in table top colour. Standard surface material veneer or high-pressure laminate.

Edsbyn Compact Profile. Straight edge strip in black. Radius 20 mm at corners. Standard surface material laminate.

LEGS

Height adjustable 650-780 mm including table top. Feet can be adjusted up to 10 mm to absorb irregularities in the floor.

The legs are available in silver, or in black or white lacquer or chromium (chromium III) for an additional charge.

The wheels add 70 mm and tolerate a load of 40 kg/wheel.

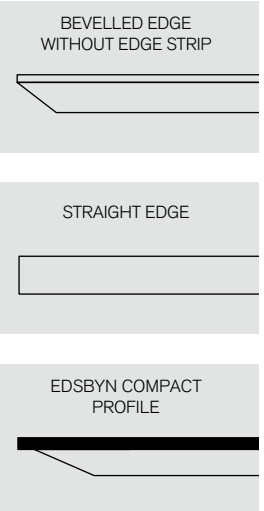



ACCESS LIGHT

The best working position is the next working position.
Vary between sitting and standing, or make just small adjustments.
Access Light is constructed to cope with daily use in tough conditions
and offer high stability, strong lifting force and a low noise level.

We only use high-quality electronics and mechanical parts to
ensure the reliability, smooth function and a long lifetime.

Attn. On my.edsyn.com and in the price list, the art. no. for table tops start with 06 and Sit'n'Stand with 08

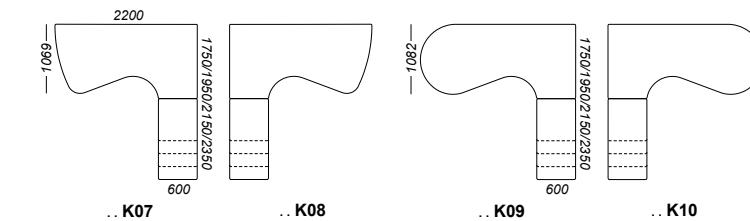
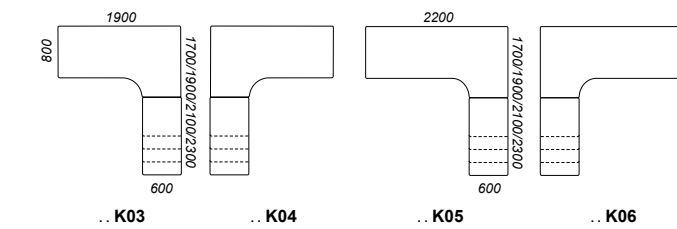
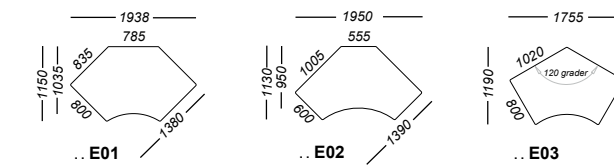
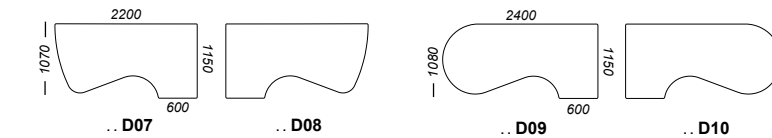
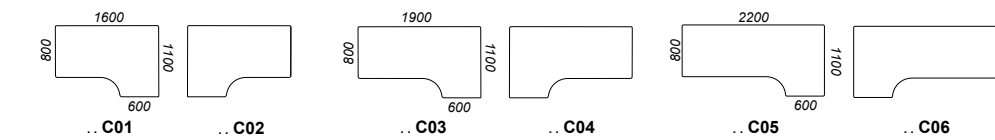
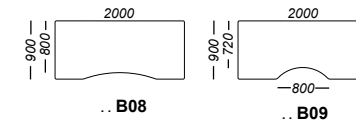
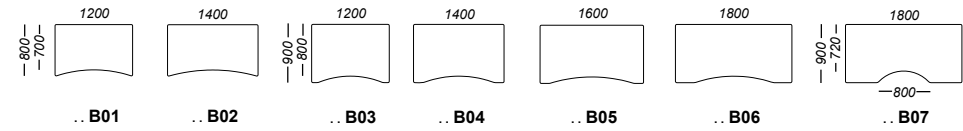
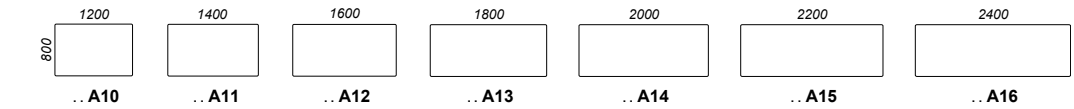

Access light (2 Legs) 08394N



Access light (3 Legs) 08395

FEET

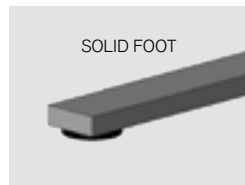

SOLID FOOT

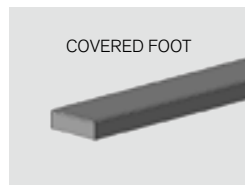

COVERED FOOT



ACCESS LIGHT FOOT

ACCESS LIGHT ACCESSORIES

Accessory bracket 2.0 09386A004 (For frame end with hook)

Accessory bracket hooked into the frame end. Needed for suspension of LiftSopi waste sorting 09678A037 or Soft Flex storage 09386A005. Also Accessory bracket has integrated hook for bag / backpack. Silver, white or black.



Soft Flex storage 09386A005

Storage bag. Hooked into Accessory bracket 2.0 for frame end (Accessory bracket 09386A004 not included, ordered separately). Grey felt.



Accessory bracket 2.0 09386A008 (For beam)

Accessory bracket for beam installation. For runner 0967800004 or 0967800009 for suspension of LiftLap and LiftSopi. Silver, white or black.



Table screen bracket Flex 2.0 09386A007

Table screen bracket for attachment to the frame end of Access Light 2.0. When selecting sliding table top, this must be used. Easy to remove the table screen. Silver, white or black.



Cable tray Flex 2.0 09386A006

Cable tray for attachment to the frame end of Access Light 2.0. When selecting sliding table top, this must be used. Silver, white or black.



Adapter for LiftSopi 09386A009

Adapter for attachment of LiftSopi waste sorting 09678A037 in Accessory bracket 2.0 for frame and 09386A004. Silver.



TECHNICAL SPECIFICATION

Beamless electrical stand with rectangular leg profile

Height-adjustment with push button.

FLEXIFRAME FUNCTION

2 Legs adjustable width: 1150-1740 mm.

3 Legs adjustable width (main tabletop): 1740-2150 mm.

Adjustable depth (side tabletop incl. main tabletop): 1540-2130 mm.

AVAILABLE IN TWO DIFFERENT HEIGHT INTERVALS

675-1175 mm, excl. table top (2-piece telescopic/leg).

605-1265 mm, excl. table top (3-piece telescopic/leg).

The electrical stand can accept approximately 100 kg of evenly distributed load (table top included).

With attachment for Access Light accessories.

2 Legs available with Access Light foot, covered foot or solid foot.



ALLROUND

Folding tables for classrooms, conference rooms etc,
which can be extended using intermediate sections. A practical table trolley
with space for 18 tables is available for Allround.

Table - depth 520 mm

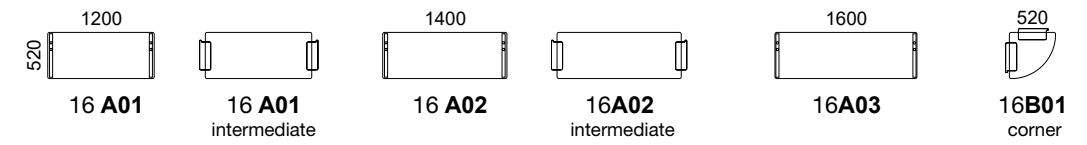

Table - depth 620 mm

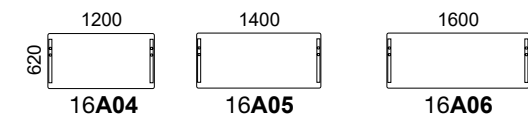
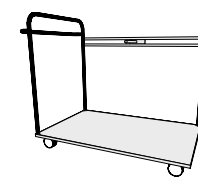
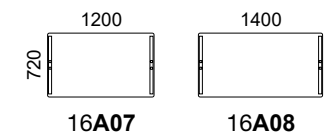

Table - depth 720 mm



1636401000

TECHNICAL SPECIFICATION

TABLE TOPS

Table tops in 22 mm MDF which are available in veneer or white/light grey laminate. The veneer is 0.6 mm thick. The colour of the edge strip is the same as the table top. ABS edge strip.

STAND

Folding standing chromium (chromium III), white or black lacquer with adjustable feet to compensate for uneven floors. Height 720 mm (inc. table top).



ARC STOOL

A solid wooden stool with a characteristically Nordic design. The elegant lines and curves of the seat are borrowed right from the Swedish National Museum's Nordic architectural style. The masterfully turned legs and foot rest lend the stool its finer details, reflecting Jens Fager's deep respect for the wood.

Design Jens Fager

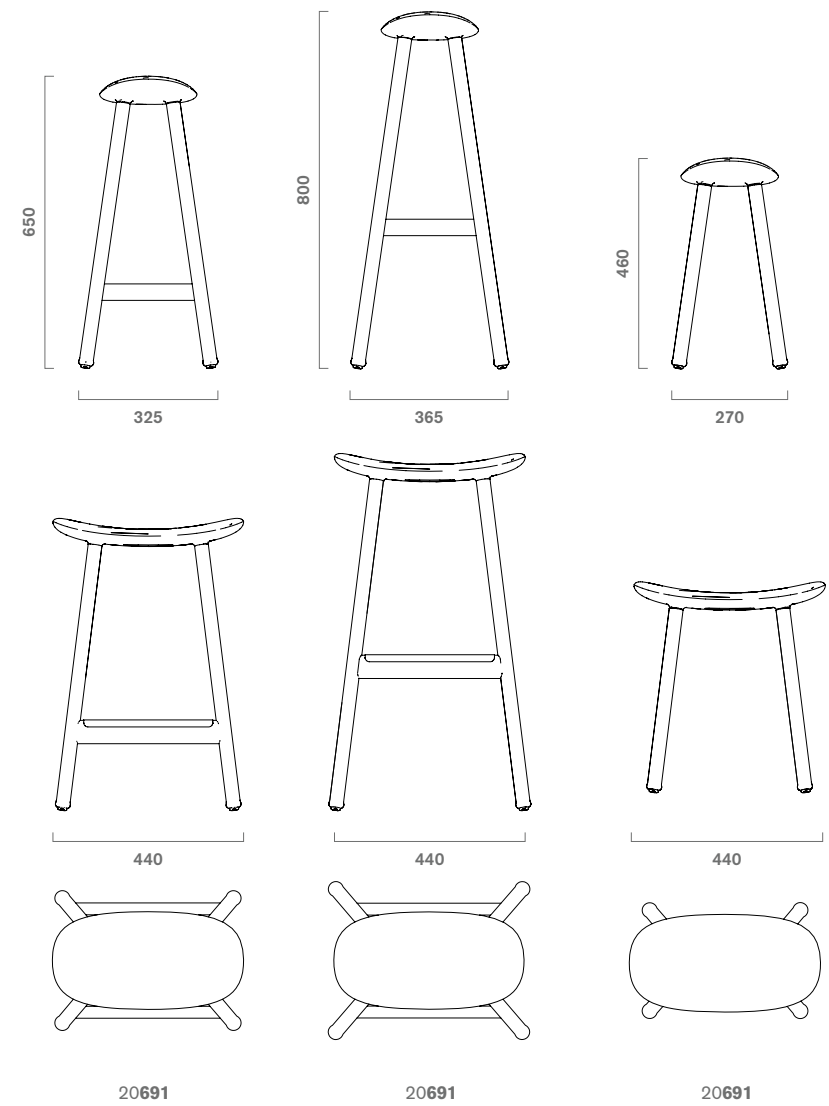



CENTRO

Centro is a series of tables that you can combine in many different ways. The table is available with tops in veneer or high-pressure laminate. Choose between three different edge profiles.

The legs are round and can be individually height adjusted.

Accessories such as desk screens, front panels or cable trays can be screwed to the table top.

By Edsbyn

RECTANGULAR

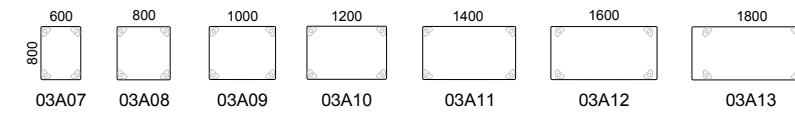
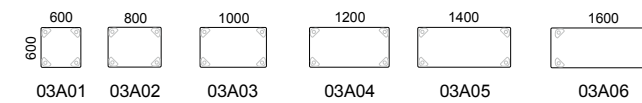

RECTANGULAR – INNER RADIUS

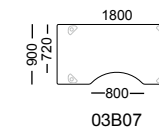
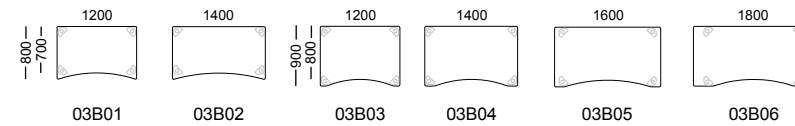

CORNER TABLE

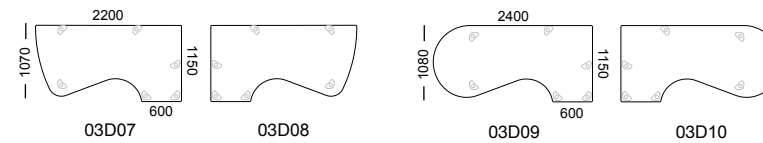
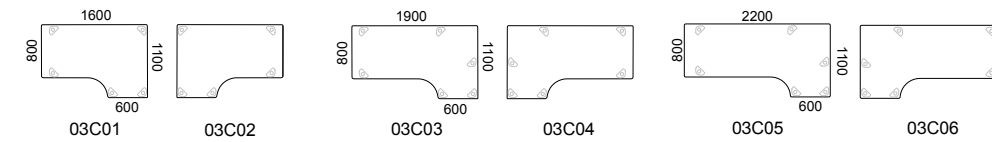

COMBI TABLE

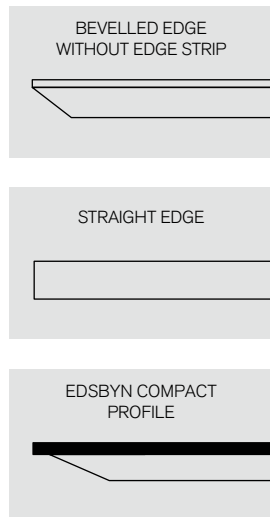
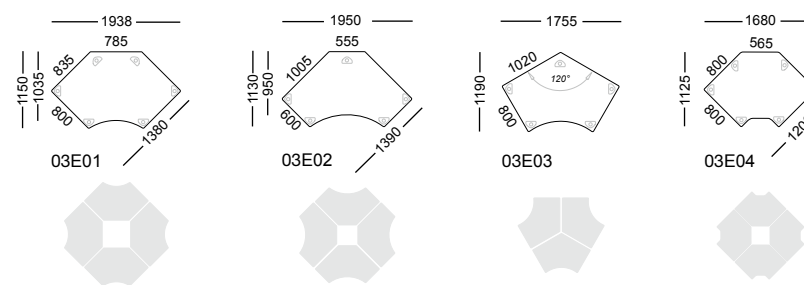

TECHNICAL SPECIFICATION

TABLE TOPS

Centro table tops consist of 22 mm MDF which is available with a number of different surface materials, such as veneer or high-pressure laminate. The veneer is 0.6 mm thick and the high-pressure laminate 0.7 mm. Tables with a high-pressure laminate surface also have a barrier laminate on the underside.

EDGE PROFILE

Bevelled edge without edge strip. Bevelled open clear lacquered MDF edges. Radius 20 mm at corners. Standard surface material veneer or high-pressure laminate.

Straight edge. Straight edge strip in table top colour. Standard surface material veneer or high-pressure laminate.

Edsbyn Compact Profile. Straight edge strip in black. Radius 20 mm at corners. Standard surface material laminate.

LEGS

Centro has round \varnothing 50 mm metal legs which are height adjustable to 650-800 mm including the table top. The legs are available in black or silver lacquered version or chromium (chromium III). Extra tall legs, for table heights of 900-920 mm (including table top) can be ordered as an option in silver or black lacquered version. Easy-to-fit wheels are available for 650-800 mm height adjustable legs (not for extra tall legs). The wheels add 60 mm and tolerate a load of 40 kg per wheel.



CLAIR CAFÉ SOFA

A neat and elegant sofa that blurs the boundary between private and public spaces with its soft lines and practical functions. With a higher seat height, Clair Café Sofa is ideal for cafes, restaurants, libraries and waiting rooms.

The straight outer contours make it easy to place in a room, and allow several sofas to be combined back to back as well as side by side.

Clair Café Sofa is designed with a tasteful “crumb gap” that keeps the furniture piece fresh and easy to clean. The back and seat are manufactured as separate units and can easily be replaced or reupholstered as needed.

The leg frame comes in one piece and does not require assembly.

Design Andreas Engesvik, Oslo



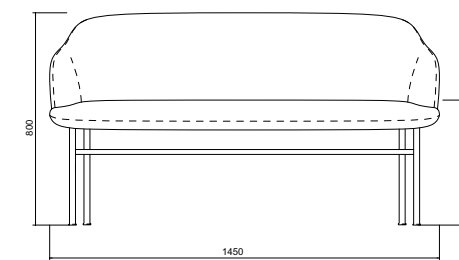
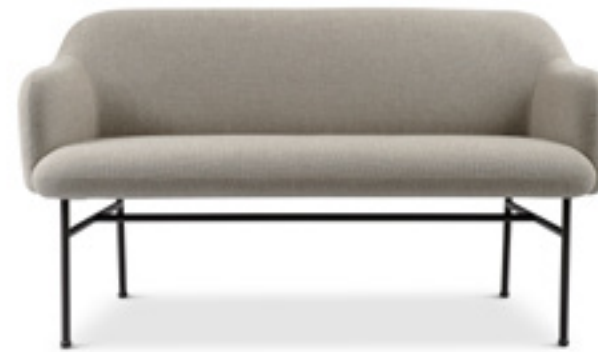

31452

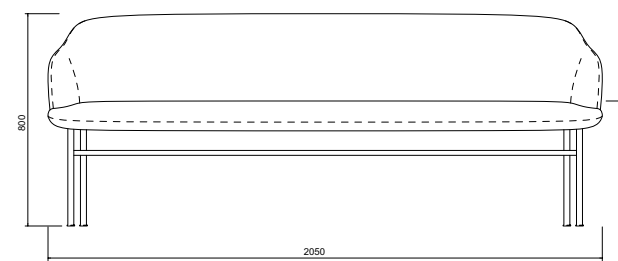
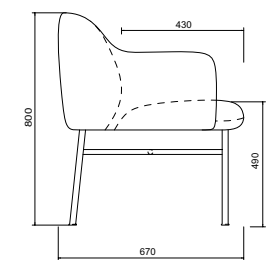

31453

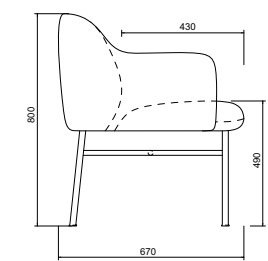

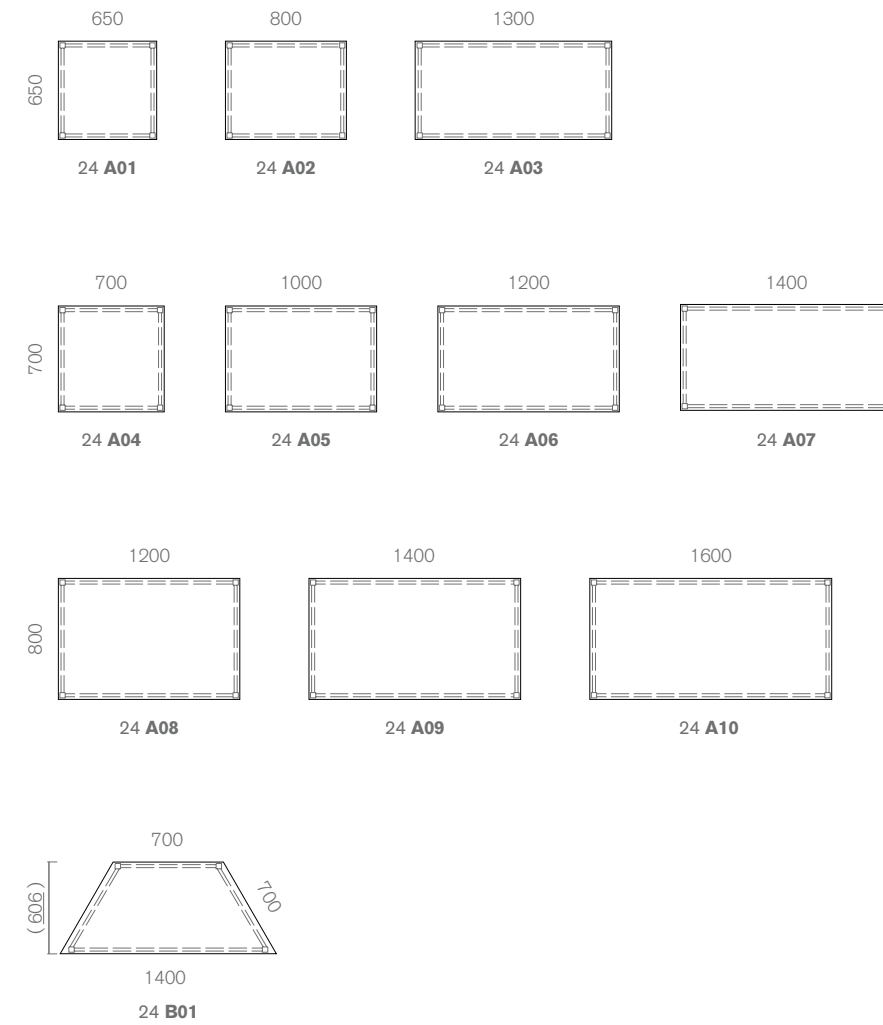

COLLEGE

College was originally developed as classroom furniture, but functions just as well as a desk or meeting table.

The trapezoidal table provides many opportunities to arrange College in a variety of layouts.





CONE TABLE

An understated design that combines easily with all types of chairs and is built to last.

Cone Table is a pedestal designed by Jens Fager to work in every type of setting. The conically shaped leg forms a stable connection to the bottom board, giving the entire design a distinctive character.

"The goal with this series of tables is to offer the market a tool that works in every type of setting" – Jens Fager

Design Jens Fager





Rectangular tables

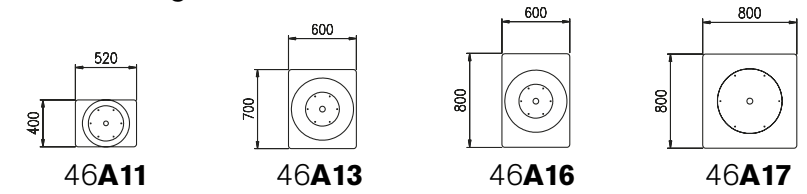

Round tables

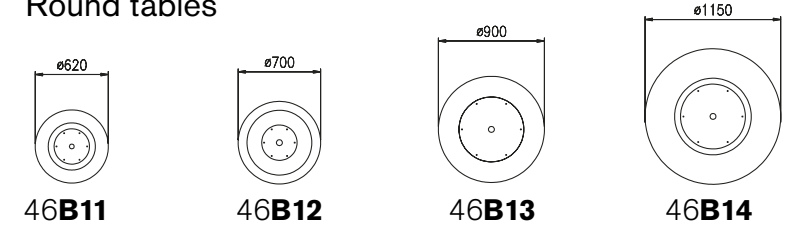

Rectangular tables with rounded corners

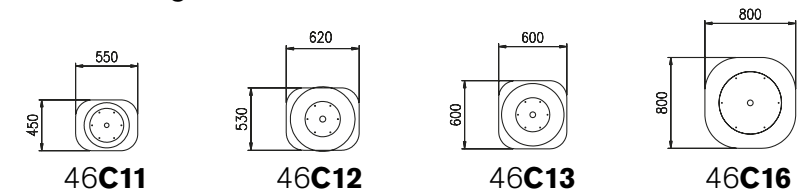

TECHNICAL SPECIFICATION

TABLE TOPS

The table tops are manufactured as 16 mm MDF with straight edges. Available in different surface materials such as veneer, desktop or high-pressure laminate. Selected table tops are also available in solid wood such as solid ash and solid oak. As well as different types of marble. Choose between Bianco Carrara (white), Verde Guatemala (green) or Emperador Dark (brown).

LEGS

Leg in White lacquer (RAL 9003), Black (RAL 9005), Dark Chocolate, Misty Grey, Chromium and Silver. Cone Table is available in heights 370, 460, 530, 600, 730, 900 and 1060 mm (inc. table top).



CONNECT

The Connect conference table is available with fixed 730 mm height stand CT3.

The legs are available in white, black or silver lacquer as standard.

Table tops are available in veneer, high-pressure laminate and desktop. The table top has bevelled edge, straight edge or Edsbyn Compact Profile.

See »Table Accessories« for cable management and other accessories for electricity, telecoms, data etc..

By Edsbyn

Conference table with CT3-foot

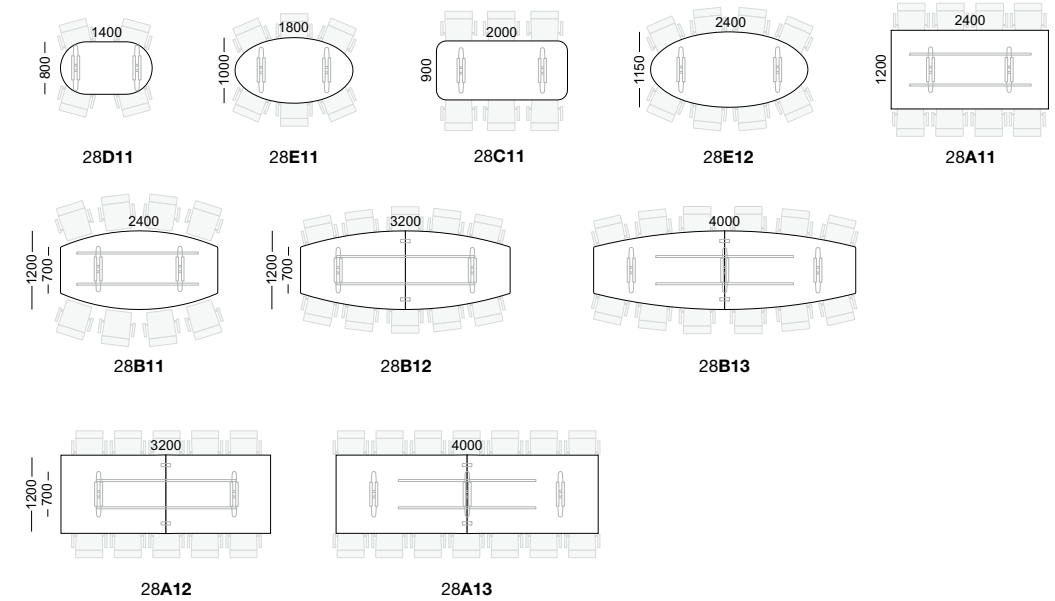

TECHNICAL SPECIFICATION

TABLE TOPS

The table tops consist of 22 mm MDF which is available in veneer or high-pressure laminate. The veneer is 0.6 mm thick and the high-pressure laminate 0.7 mm. Tables with a high-pressure laminate surface also have a barrier laminate on the underside.

Cable holes are included in all table top combinations.

EDGE PROFILE

Bevelled edge without edge strip. Bevelled open clear lacquered MDF edges. Radius 20 mm at corners. Standard surface material veneer or high-pressure laminate.

Straight edge. Straight edge strip in table top colour. Standard surface material veneer or high-pressure laminate.

Edsbyn Compact Profile. Straight edge strip in black. Radius 20 mm at corners. Standard surface material laminate.

Veneer is a living material and Edsbyn takes no responsibility for the variation that may occur in color or structure of delivered products

STAND

Connect pillar foot in 730 mm height (inc. table top) in white, black or silver lacquer.



DESK SCREENS

Edsbyn's table screens help employees in open plan offices to focus on their tasks.

Choose between fabric-clad table screens and table screens in wood.

The choice depends on whether you need table screens for sound absorption or visual separation.

The screens are available in different widths to fit different types of table.

There are also many different functional accessories for the fabric-clad or wooden screens.



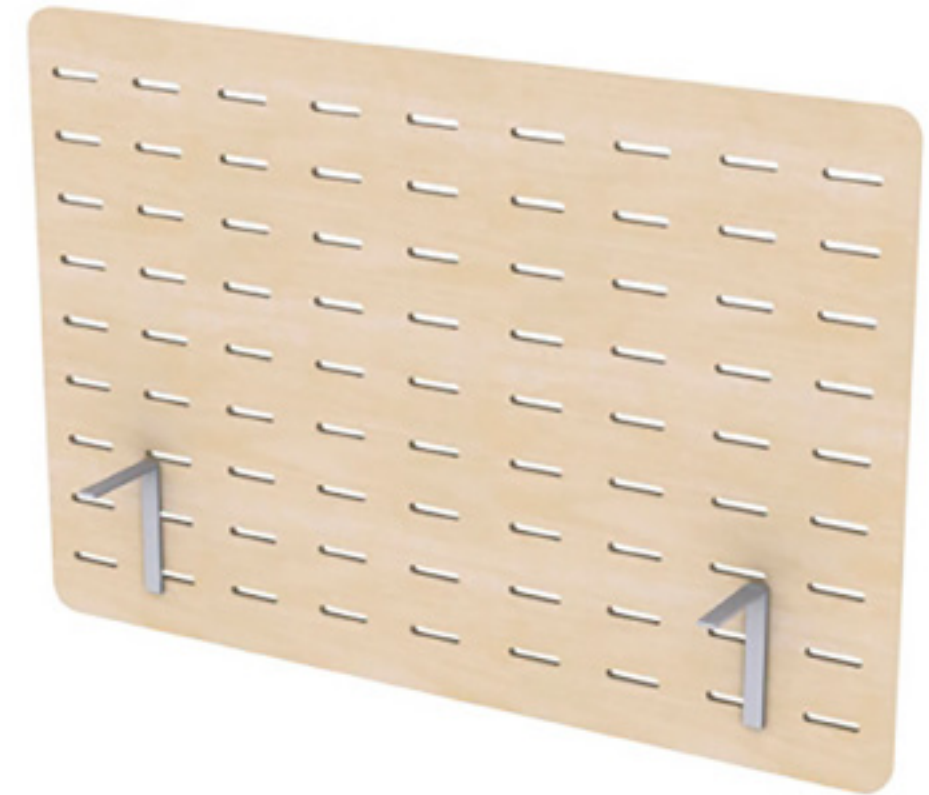
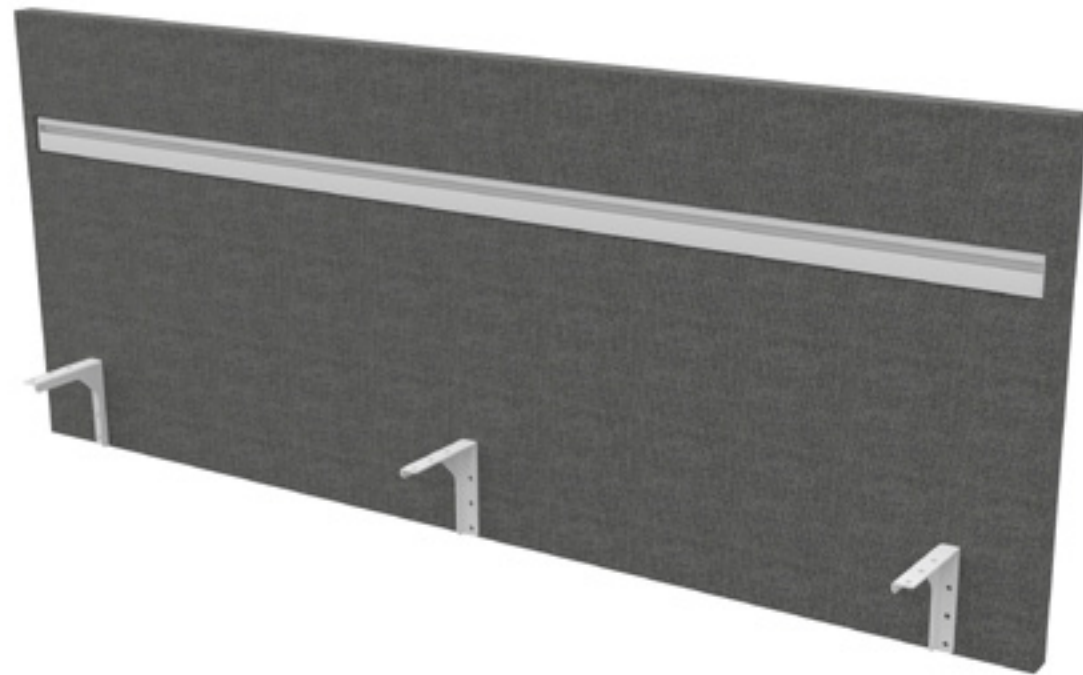
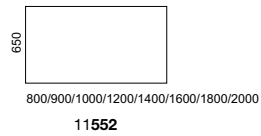
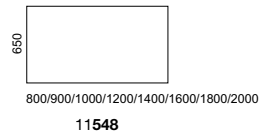

Table screen Fabric

Textile covered fiberboard.
16 mm thickness. Height 650 mm.



Fiberboard with sound absorbing material on two sides.
Textile covered. 30 mm thickness. Height 650 mm.



Fiberboard with sound absorbing material on two sides.
Textile covered. 36 mm thickness. Height 650 mm.
With recessed Edsbyn accessory strip, 09670.

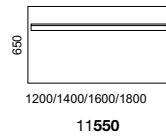

Fiberboard with sound absorbing material on two sides.
Textile covered. 36 mm thickness. Height 650 mm.
With recessed Conceptum accessory strip.

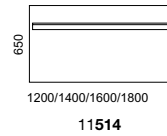

Textile covered fiberboard with round corners
(radius 40 mm). 16 mm thickness.
Height 650 mm.

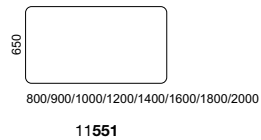

Fiberboard with round corners (radius 40 mm), sound
absorbing material on two sides. Textile covered.
30 mm thickness. Height 650 mm.

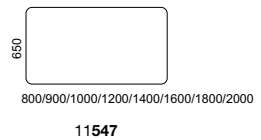

Fiberboard with round corners (radius 40 mm), sound absorbing
material on two sides. Textile covered. 36 mm thickness.
Height 650 mm. With recessed Edsbyn accessory strip, 09670.

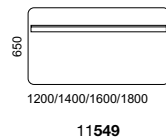

Fiberboard with round corners (radius 40 mm), sound absorbing
material on two sides. Textile covered. 36 mm thickness.
Height 650 mm. With recessed Conceptum accessory strip.

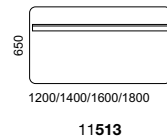
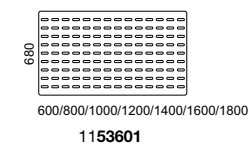
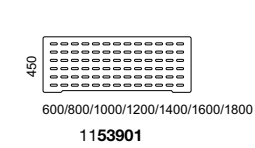

Table screen Wood

Height 680mm. Thickness 11mm. Table brackets placed
in any of the slots. Table screen can thus be regulated in
height, over / under the table top.



Height 450mm. Thickness 11mm. Permanently mounted vertically.
Can also be screwed under the table as a front panel.





EASE

Not merely a screen system. Ease is probably one of the market's most versatile furniture programmes, providing everything from standing or hanging room dividers to clean workplaces, interview rooms, seating areas and suspended ceilings.

Attractive accessories such as clothing hooks and shelves make it easy to create interesting environments. Ease is perfect for the creative process! Simply pin sketches and inspiration images onto the Ease screens.

Because Ease is manufactured from a material normally used for sound absorption in the vehicle industry, Ease is perfect for environments where you need to reduce noise levels. The material consists of recycled PET bottles and textiles which are compressed into self-supporting screen elements. The design is unique in the world, patented and Nordic Ecolabelled.

Design Jens Fager & Andreas Engesvik



EASE SOFA

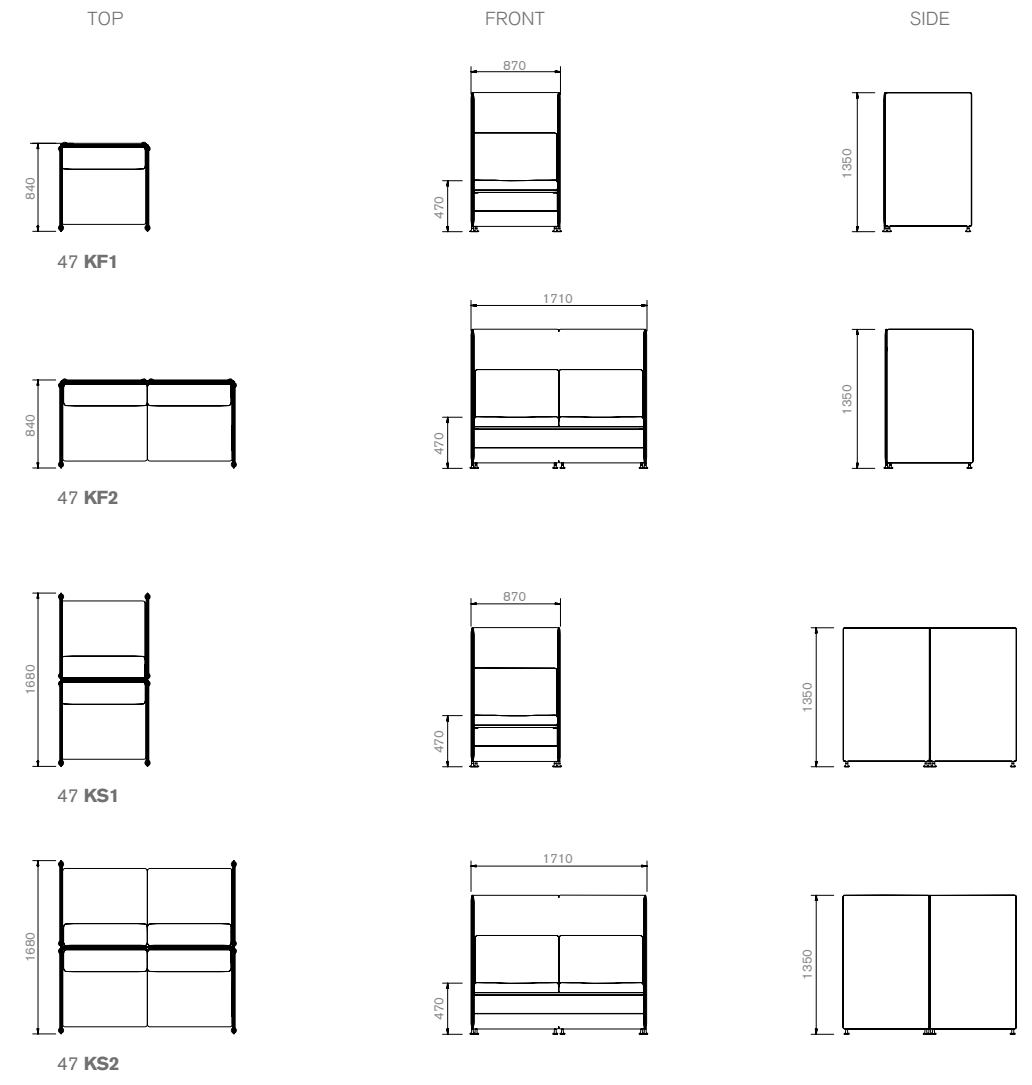



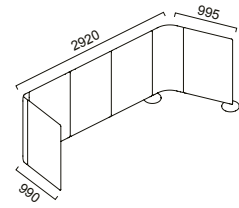

47KC1

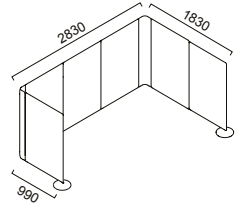

47KC2

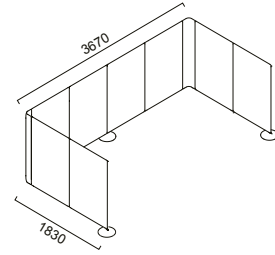

47KC3

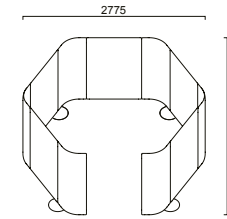

47KD1

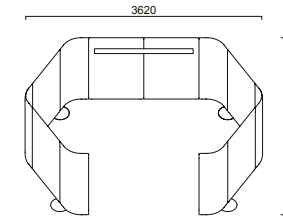

47KD2

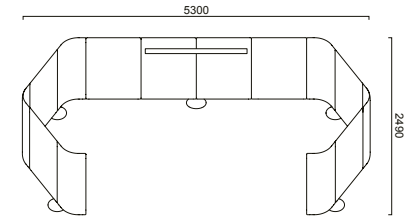

47KD3

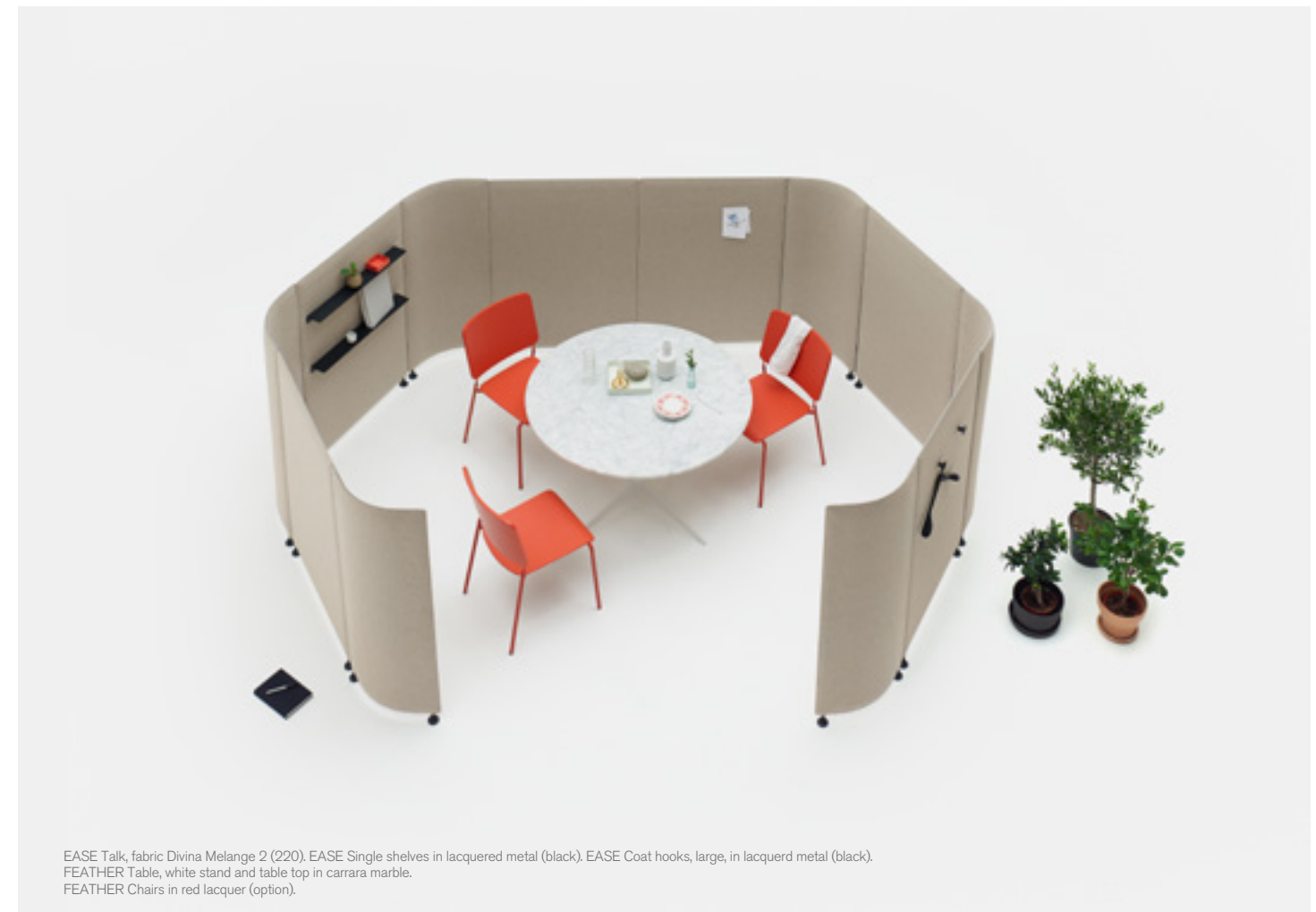

EASE Talk, fabric Divina Melange 2 (220). EASE Single shelves in lacquered metal (black). EASE Coat hooks, large, in lacquered metal (black). FEATHER Table, white stand and table top in carrara marble. FEATHER Chairs in red lacquer (option).





EASE PENDANTS

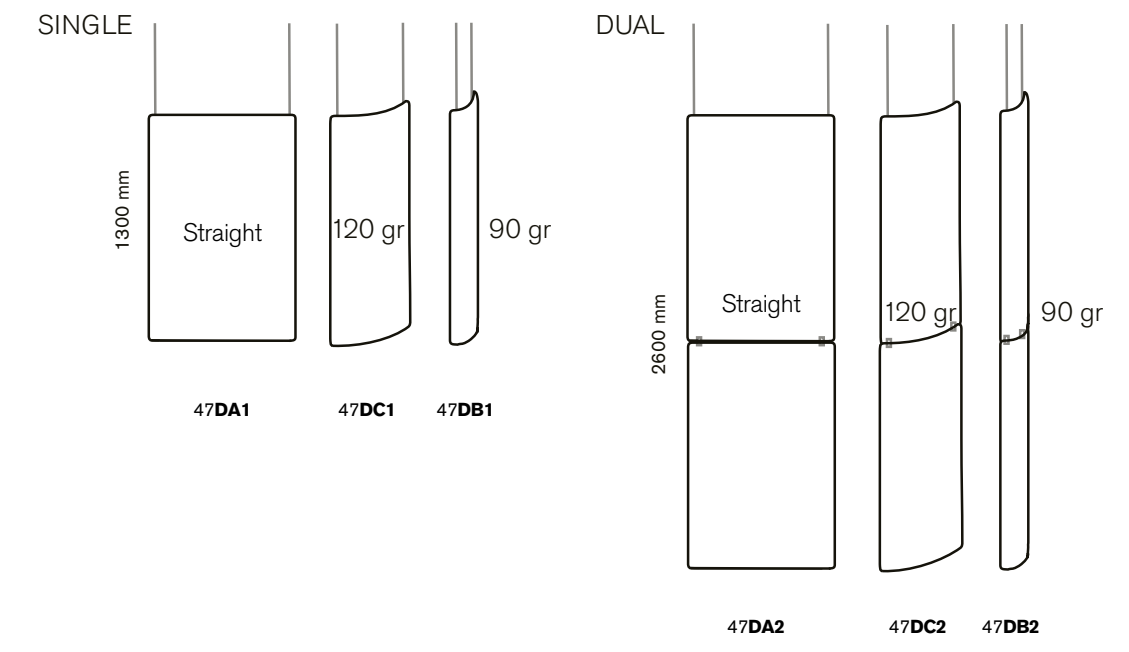

EASE WALL

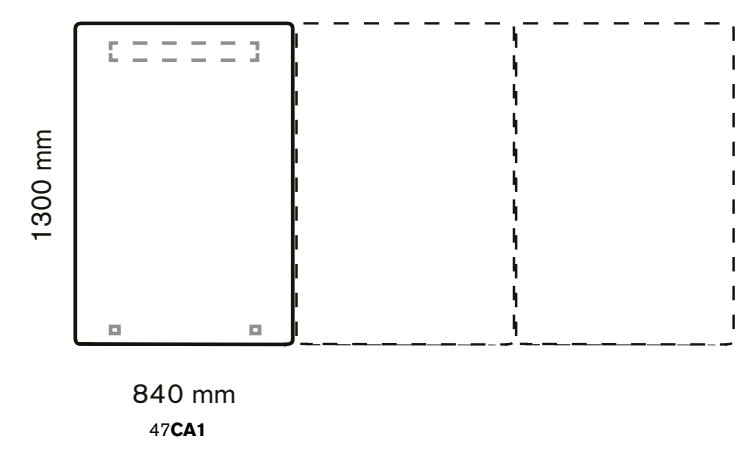

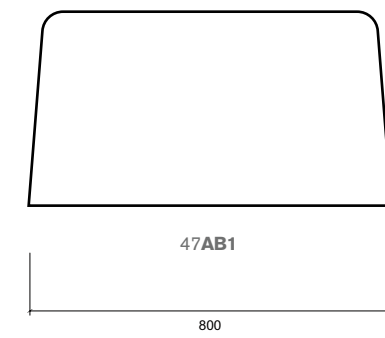
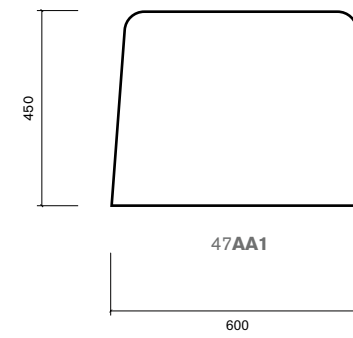

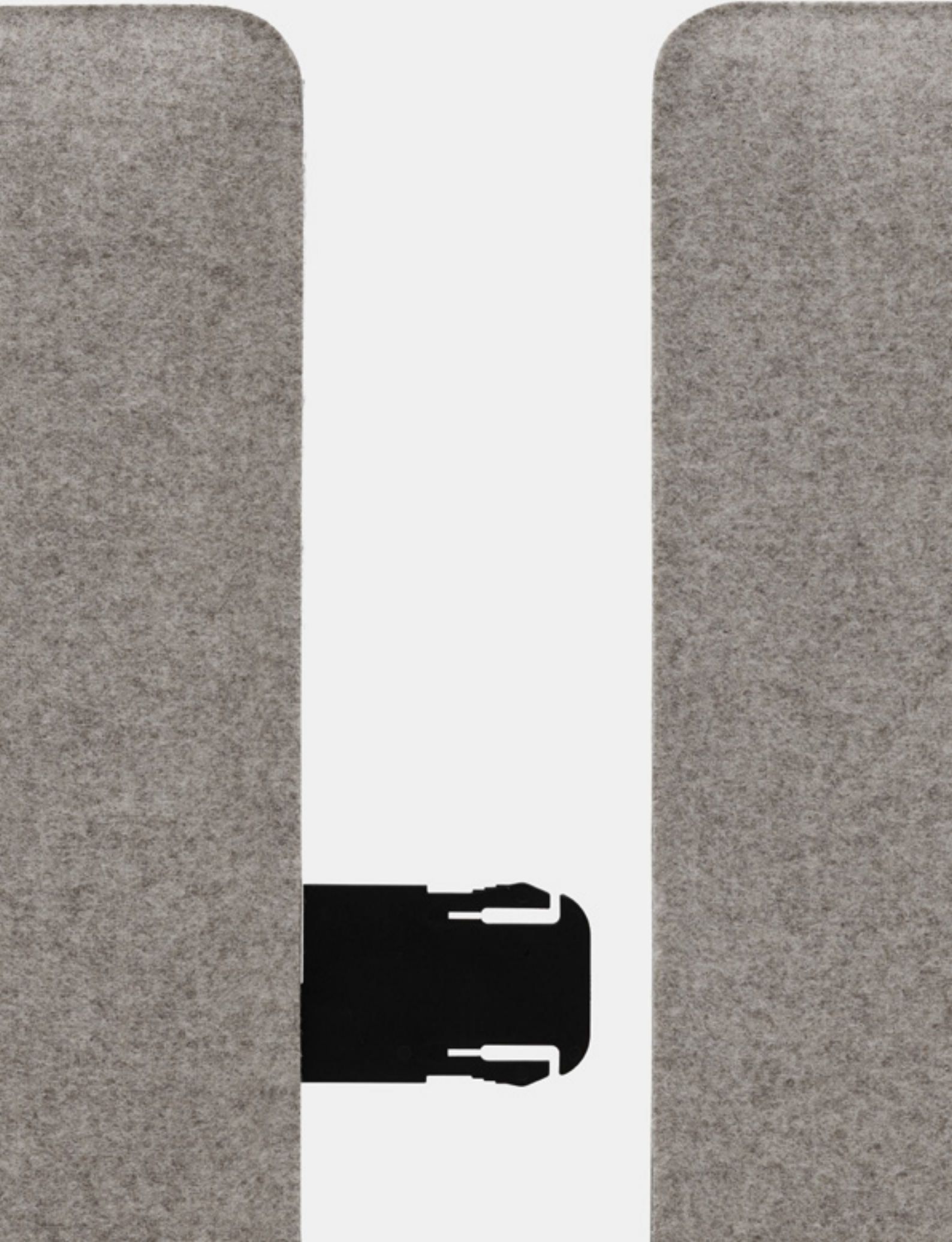

Dimensions floor screen

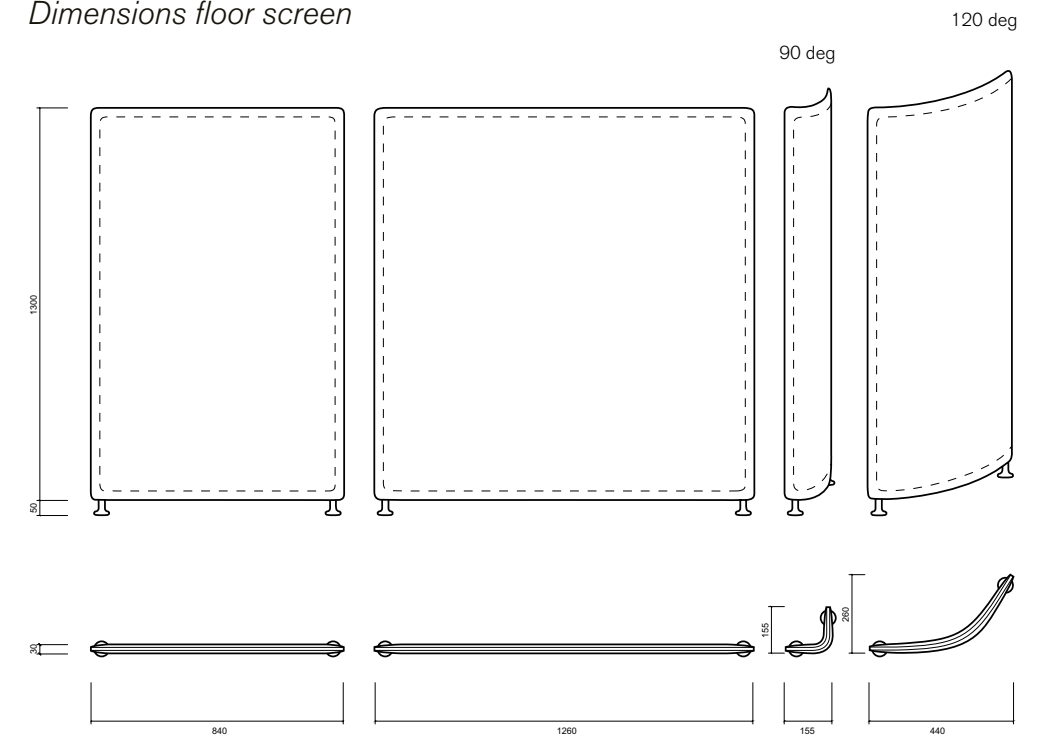

ACCESSORIES / OPTIONS

Clothes hook
 - small ● ■
 - large ● ■

Single foot

Supporting foot
 - end ●
 - connected ●

Shelves
 - single 710 mm
 - double 1550 mm

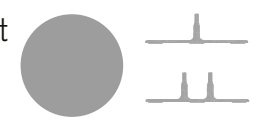



EASE Work one way, fabric: Divina MD (973). EASE Table top in cedar.
EASE Single shelf in lacquered metal (white). EASE Large coat hook in lacquered metal (black).
FEATHER Chair and stool in lacquer.

WORK ONE WAY

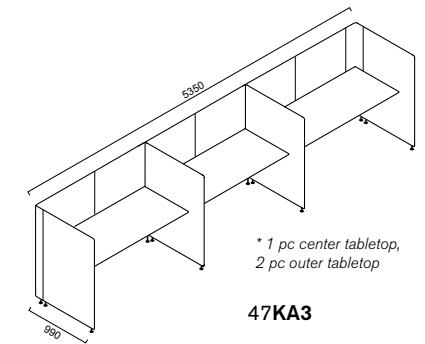
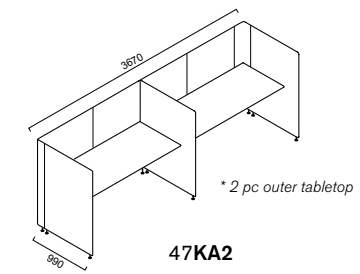
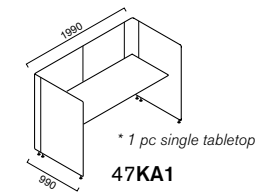

EASE Work dual, fabric: Divina Melange 2 (531). EASE Table top in white glazed ash. EASE Single shelves in lacquered metal (black). EASE Large coat hooks in lacquered metal (black).
FEATHER Swivel chair, white stand and brown leather (33004).

WORK DUAL

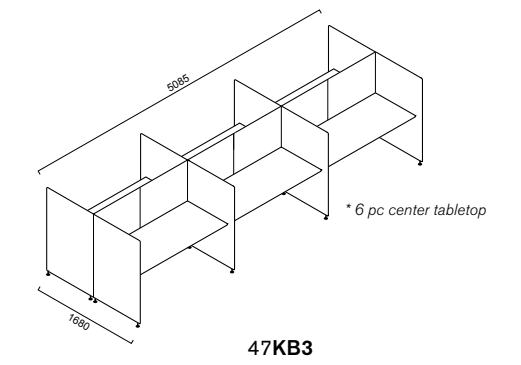
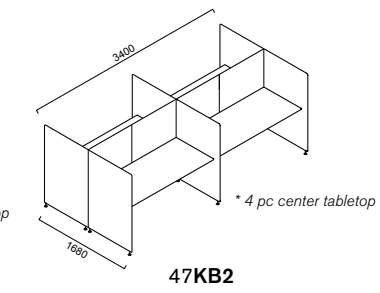
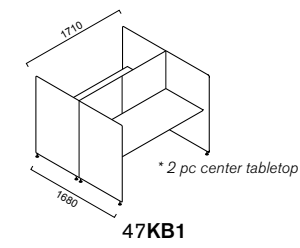

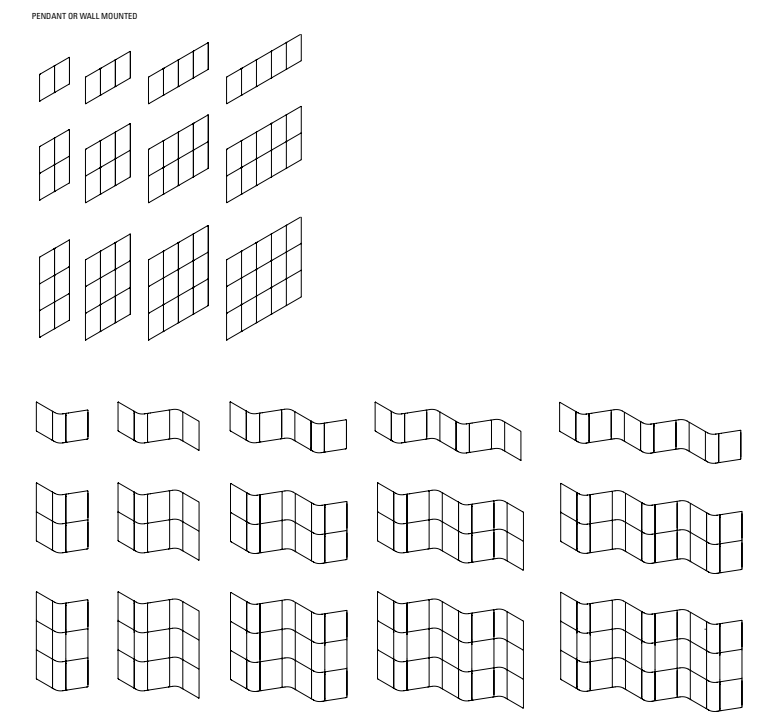
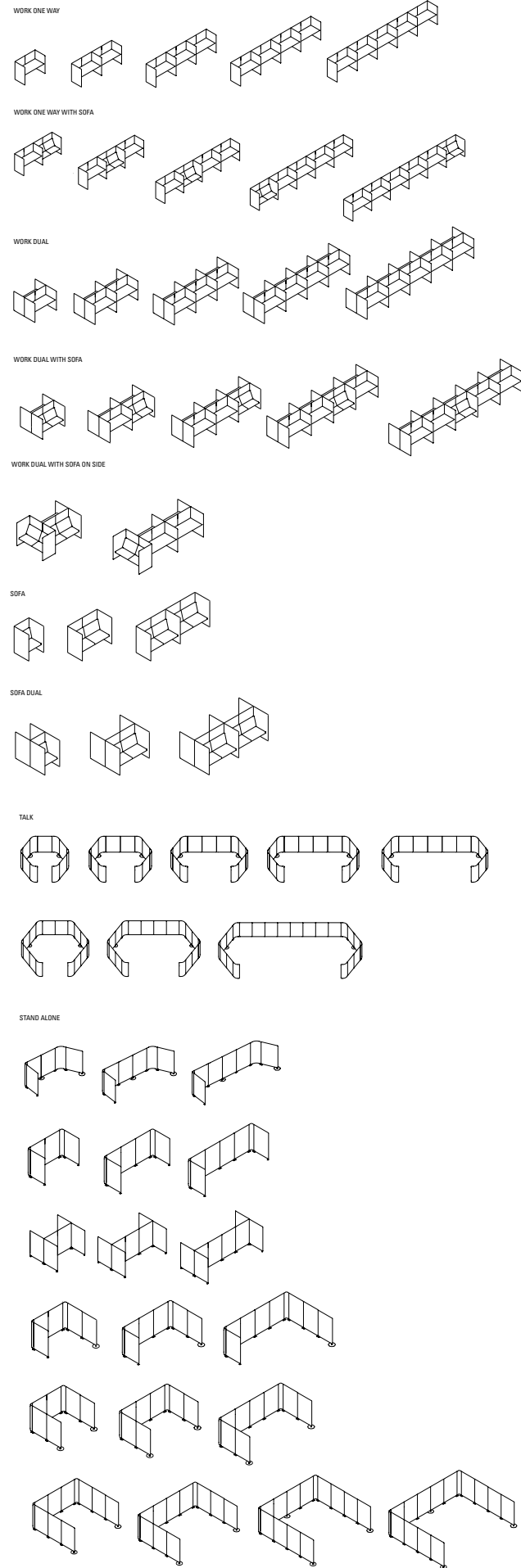

Ease is probably one of the market's most versatile furniture programmes, providing everything from standing or hanging room dividers to clean workplaces, interview rooms, seating areas and suspended ceilings.





EMBRACE FLOOR SCREEN

A sound absorbing floor screen with Soundfelt that divides and encloses. Create a balanced environment in the working area for better efficiency, focus and wellbeing.

The screen is available with small feet for unlimited combinations of connected screens, to create a room in the room, or with larger feet for free standing.

Soundfelt is an environmentally smart product made from a high proportion of recycled PET bottles and has a good sound absorption capability.

Attach pins directly on the screen and use it as a pin board.

By Edsbyn



Fiberboard with sound absorbing material on two sides.
Textile covered. 36 mm thickness. Height 1400 mm.

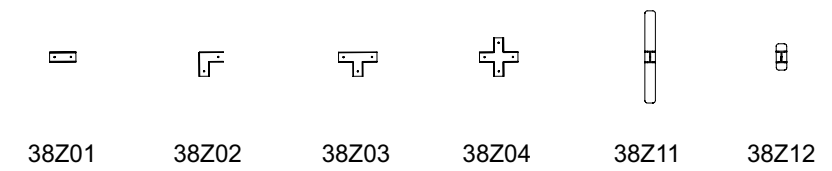
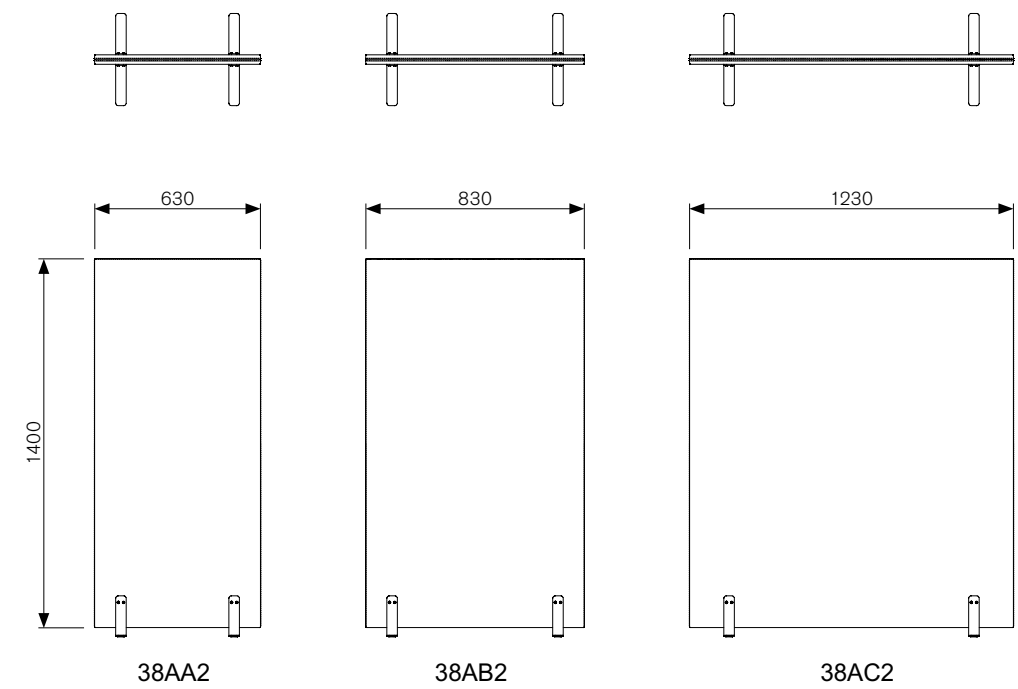

TECHNICAL SPECIFICATION

SCREEN

Height: 1400 mm (1435 mm incl. Foot)
Width: 630 mm, 830 mm, 1230 mm

Corner: Straight
Textile: Free choice from Edsbyn's regular screen fabrics

FOOT

Length: 350 mm (freestanding screen) & 100 mm (connected screen)
Lacquer: Black, white and silver

CONNECTION FITTINGS

Angle Straight, Angle 90 degrees, 3-way T-coupling & 4-way T-coupling



E-POS

E-POS is available as armchair, sofa, stool and table.

Since less is more E-Pos table blends into any environment with its sleek design.

Design Sture Eng & Dan Ihreborn

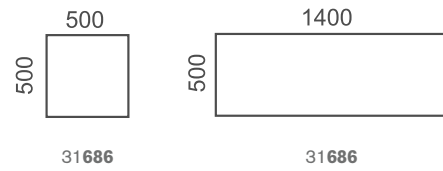

e-pos armchairs

Wooden frame, filling of polyether. Seat height 470 mm.



W:580 x D:600 mm

31685



W:600 x D:660 mm

31681

2 and 3 seater sofas / Bench

Wooden frame, filling of polyether. Seat height 460 mm.



W:1200 x D:700 mm

31682



W:1800 x D:700 mm

31683



W:1200 x D:600 mm

31684

Item width	Fabric required at fabric width	Fabric required at fabric
31 685	1,90 m / 150 cm	2,00 m / 130-140 cm
31 681	3,00 m / 140-150 cm	3,30 m / 130 cm
31 682	4,40 m / 140-150 cm	4,80 m / 130 cm
31 683	4,90 m / 150 cm	5,40 m / 130-140 cm

Corner sofas / long sofas

Wooden frame, filling of polyether. Seat height 460 mm.



31688 (corner sofas)

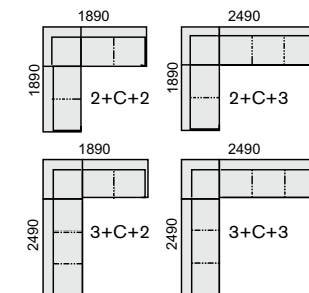

Fabric required:
 2+C+2 = 10,6 m
 2+C+3 = 11,4 m
 3+C+3 = 12,2 m



EVE

EVE offers a wide programme of office chairs, giving you the opportunity to choose a chair that perfectly suits you and your work tasks. EVE is available in a range of price classes and equipment options, with various mechanisms to control how the chair follows the body.



EVE 100

With permanent (not lockable) swing. Adjustable inertia in the rocking mechanism. Star base and wheels in black nylon. Black gas lift. Available in fabric Event black (No 60999).



19 507
Low backrest
Fabric requirement: 0,6 m



19 507
High backrest
Fabric requirement: 0,8 m



Armrest for EVE 100

EVE 200

With Freefloat mechanism. Adjustable tilt resistance for back pad. Adjustable backrest height. Wheels (braked) for hard and soft floors. Adjustable armrests (width / height / angle / depth). EVE 200 is tested and approved, classified type A.



19 508
Low backrest
Fabric requirement: 1,1 m



19 508
High backrest
Fabric requirement: 1,2 m



Optional for EVE 200
- Sliding seat, sliding 50 mm
- Raised pneumatic cylinder seat height 500-700mm
- Raised pneumatic cylinder incl. chrome foot ring

EVE 300 Synchronous

Lockable synchronic with anti-shock system. Seat depth adjustment. Adjustable lumbar and back height. Adjustable armrests (width / height / angle / depth). Wheels (braked) with rubber tread for hard and soft floors. EVE 300 is tested and approved, classified type A.

EVE 300 Freefloat

With FreeFloat mechanism. Seat depth adjustment. Adjustable lumbar and back height. Adjustable armrests (width / height / angle / depth). Wheels (braked) with rubber tread for hard and soft floors. EVE 300 is tested and approved, classified type A.



19 509 (Synchronous)
19 510 (Freefloat)
Medium backrest
Fabric requirement: 1,2 m



19 509 (Synchronous)
19 510 (Freefloat)
High backrest
Fabric requirement: 1,3 m



Optional for EVE 300
- Headrest in the selected fabric (only with high backrest)
- Head rest in black leather (only with high backrest)
- Raised pneumatic cylinder seat height 500-700 mm
- Raised pneumatic cylinder incl. chrome foot ring



Adjustable width
(whole armrest)



Adjustable height



Adjustable depth



Adjustable width
(armrest pad)



Tiltable



FEATHER

All of the furniture in the Feather family has carefully designed details. Examples of this on the chairs are the change in dimensions in the transition between the legs and the back support attachment, and how the radiuses of the back support, seats and legs complement each other.

These make Feather a »silent chair« with character!

The name Feather reflects its elegance and resilience. The attachment of the back is not merely attractive, it also provides a resilient effect which gives very good seating comfort.

The chairs in the Feather family are versatile and adaptable, and can be used in many different environments, from offices to conference spaces, restaurants and schools. The design is so attractive that it even works in a domestic environment.

The variations available in terms of colour, form and material make it possible to give your interior decoration a personal touch.

Design Jens Fager





Feather

Chair with metal frame white, silver laquer alt. chrome. Molded seat and backrest. Armrests has a metal body covered with black or grey rubber. Stackable and suspendable.



31634
Total height: 845mm. Total width: 490mm (545 mm with armrests). Total depth: 550mm. Seat height: 450mm. Seat width: 400mm. Seat depth: 425mm.

Fabric requirement: Upholstered backrest and seat 0,95m/pcs.
Fabric requirement: Upholstered backrest and seat 0,95m/pcs

Feather Swivel

Chair with metal frame white, silver laquer (deep silver) alt. chrome. Molded seat and backrest. Armrests has a metal body covered with black or grey rubber. Suspendable.



31622
Total height: 845mm. Total width: 610mm. Total depth: 660mm. Seat height: 450mm. Seat width: 415mm. Seat depth: 425mm.

Fabric requirement: Upholstered backrest and seat 0,95m/pcs
Seat: 0,47m/pcs (when purchase 1-3 pcs) 0,35m/pcs (over 4 pcs)

Feather Swivel adjust

Chair with pneumatic cylinder. Metal frame white, silver laquer (deep silver) alt. chrome. Molded seat and backrest. Armrests has a metal body covered with black or grey rubber. Suspendable.



31626
Total height: 815-905mm. Total width: 610mm. Total depth: 660mm. Seat height: 420-510mm. Seat width: 415mm. Seat depth: 425mm.

Fabric requirement: Upholstered backrest and seat 0,95m/pcs
Seat: 0,47m/pcs (when purchase 1-3 pcs) 0,35m/pcs (over 4 pcs)

Writing tablet (for Feather)

Width 260 mm, Depth 190 mm



3162200
Tablet: Birch, Oak, Black stained oak, White stained ash or Black desktop.
Metal: White, Silver, Chrome

Connection fitting (for Feather)

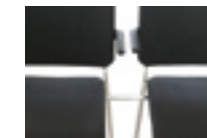

3163400002
Chrome

Trolley (for Feather)

Width 390 mm, Height 924 mm, Depth 430 mm.



3163400001
Chrome

Feather armchair



31636
Total height: 845mm. Total width: 540mm. Total depth: 550mm. Seat height: 450mm. Seat width: 400mm. Seat depth: 425mm.

Feather Lounge

Chair with metal frame white, black, silver laquer alt. chrome. Molded seat and backrest. Armrests has a metal body covered with black or grey rubber. Stackable.



31666
Total height: 780mm. Total width: 570mm (675 mm with armrests). Total depth: 660mm. Seat height: 410mm. Seat width: 510mm. Seat depth: 515mm. Stackable (8 chairs)

Fabric requirement: same as Feather

Feather Lounge Swivel

Rotatable chair with metal frame white, black, silver laquer alt. chrome. Molded seat and backrest. Armrests has a metal body covered with black or grey rubber.



31667
Total height: 780mm. Total width: 570mm (675 mm with armrests). Total depth: 660mm. Seat height: 410mm. Seat width: 510mm. Seat depth: 515mm.

Fabric requirement: same as Feather

Feather Swivel armchair



31668
Total height: 845mm. Total width: 610mm. Total depth: 660mm. Seat height: 450mm. Seat width: 415mm. Seat depth: 425mm.

Feather Swivel Adjust armchair



31669
Total height 815-905mm. Total width: 610mm. Total depth: 660mm. Seat height: 420-510mm. Seat width: 415mm. Seat depth: 425mm.

Feather Stool

Chair with metal frame in white, black, silver laquer alt. chrome. Molded seat. Seat width: 345 mm. Seat depth: 394 mm.

Medium



20661
Chair for table height 900 mm. Footrest in chrome. Total width: 393 mm. Total depth: 408 mm. Seat height: 650 mm. Measure between the seat and footrest: 460 mm.

Fabric requirement: 0,25m (when purchase of 1 pcs)
0,5m (when purchase of 2 pcs).

Large



20662
Chair for table height 1060 mm. Footrest in chrome. Total width: 424 mm. Total depth: 439 mm. Seat height: 800 mm. Measure between the seat and footrest: 460 mm.

Fabric requirement: 0,25m (when purchase of 1 pcs)
0,5m (when purchase of 2 pcs).



FEATHER TABLE



Height 370 mm, 460 mm

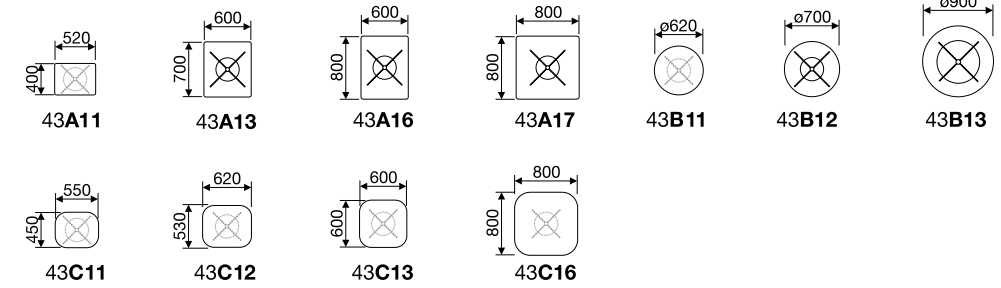

Height 530 mm, 600 mm

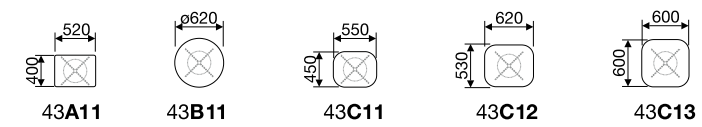

Height 730 mm

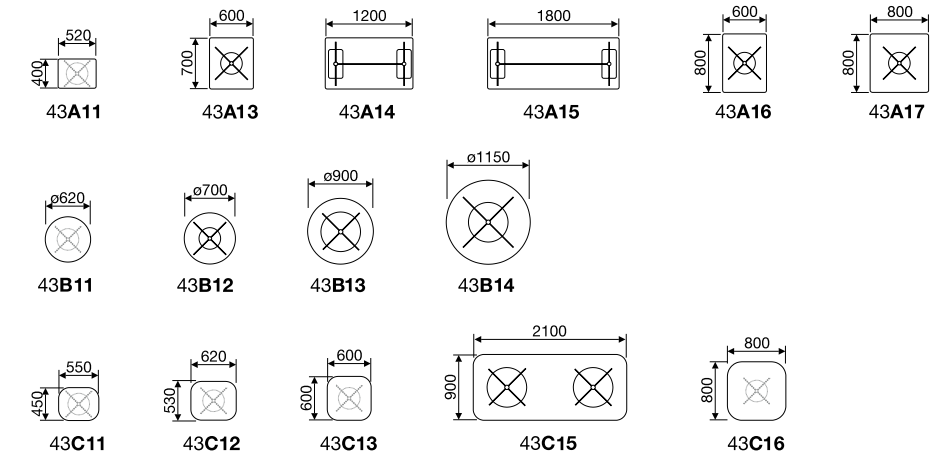

Height 900 mm, 1060 mm

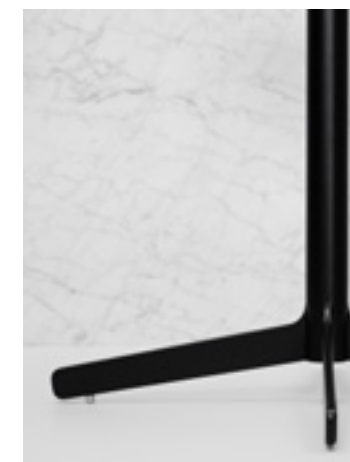
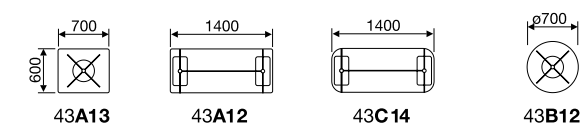

TECHNICAL SPECIFICATION

TABLE TOPS

The table tops are manufactured as 16 mm MDF with straight edges. Available in different surface materials such as veneer, desktop or high-pressure laminate. Selected table tops are also available in solid wood such as solid ash and solid oak. As well as different types of marble. Choose between Bianco Carrara (white), Verde Guatemala (green), Emperador Dark (brown).

LEGS

Leg in White lacquer (RAL 9003), Black (RAL 9005), Dark Chocolate, Misty Grey, Chromium and Silver. Feather Table is available in heights 370, 460, 530, 600, 730, 900 and 1060 mm (inc. table top).





Rectangular tables D: 1100 mm

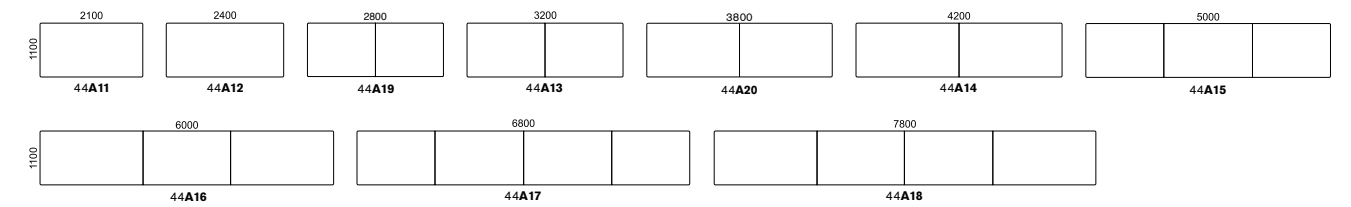

Tables with rounded corners D: 1100 mm

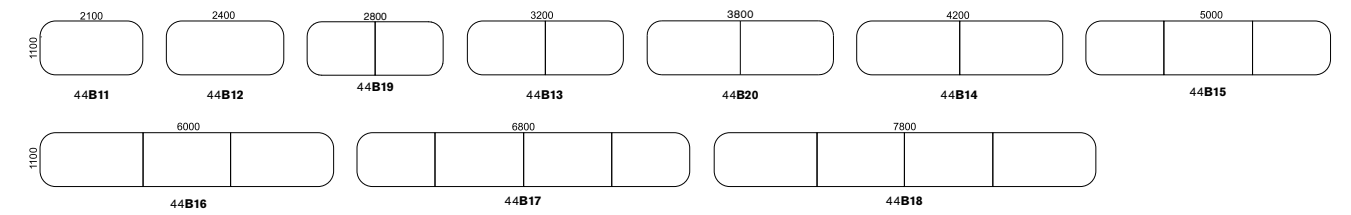

Intermediate top D: 1100 mm

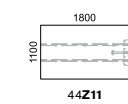

Example of intermediate top usage



Rectangular tables D: 1250 mm

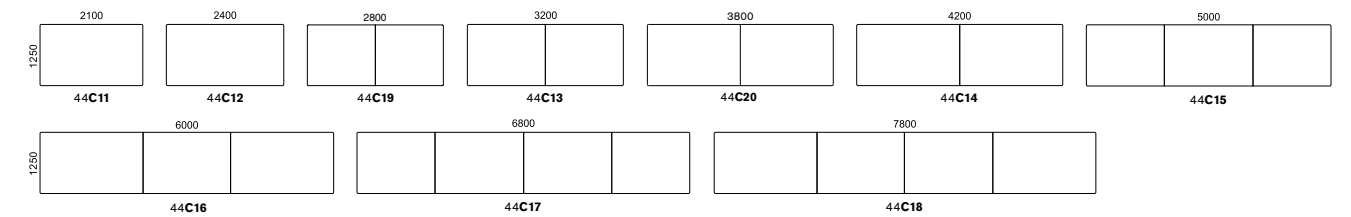

Tables with rounded corners D: 1250

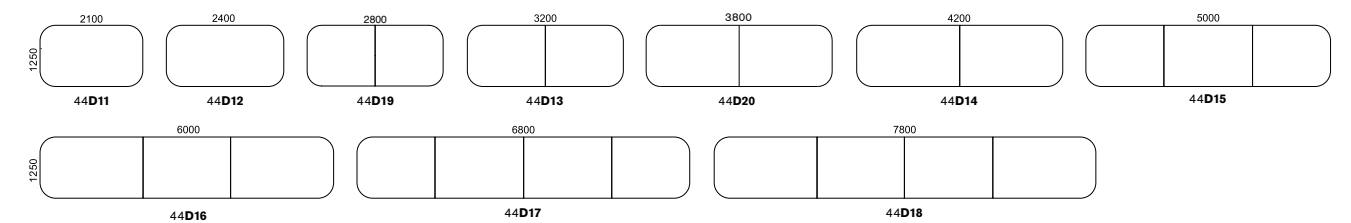

Intermediate top D: 1250 mm

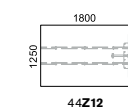

Example of intermediate top usage



Feather V

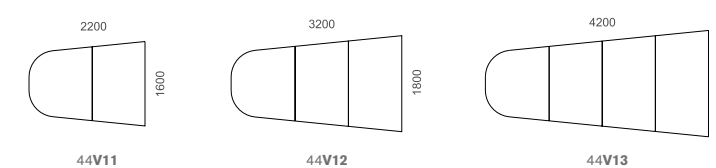

TECHNICAL SPECIFICATION

TABLE TOPS

The table tops are manufactured as 19 mm MDF with straight edges. Available in different surface materials such as veneer, desktop or high-pressure laminate.

Veneer is a living material and Edsbyn takes no responsibility for the variation that may occur in color or structure of delivered products

LEGS

Leg in white lacquer (RAL 9003), black (RAL 9005), Dark chocolate, Misty grey, chromium and silver. The Feather table is available in 730 mm height (inc. table top).



GATHER

Combining the best of two worlds; the practicality of a modular system and the aesthetics of a stand-alone sofa. Create the most suitable configurations for your needs without compromising on aesthetics or comfort.

Slender legs are mounted on a solid steel frame with separate modules placed on top. This gives the programme several benefits in terms of production, logistics, configurations and assembly. The holistic expression of Gather is based on its chunky yet fitted volumes intersected by the characteristic seam running around the sofa. A perfect sofa for the workplace or even the home.

Design Andreas Engesvik



SOFAS - CONFIGURATIONS

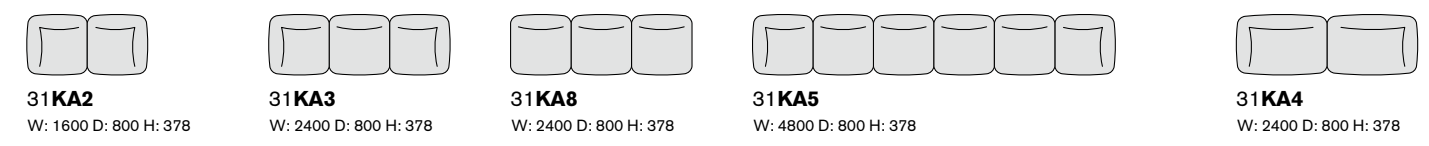

SOFAS - WITH CHAISE LONGUE

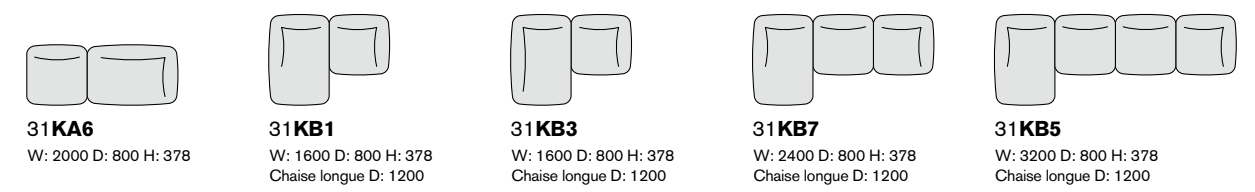

CORNER SOFAS

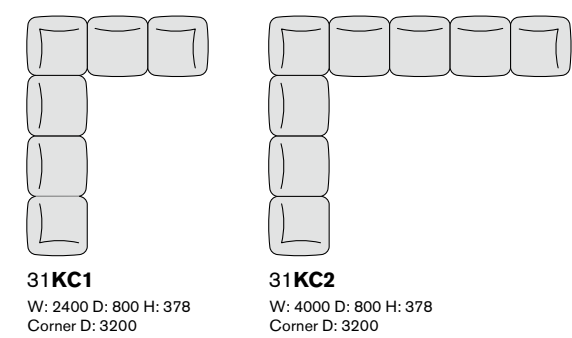

SOFAS - FOOTSTOOLS

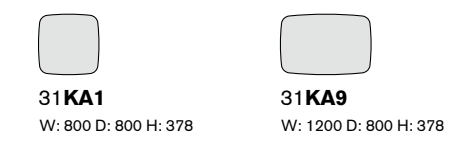

MEASUREMENTS

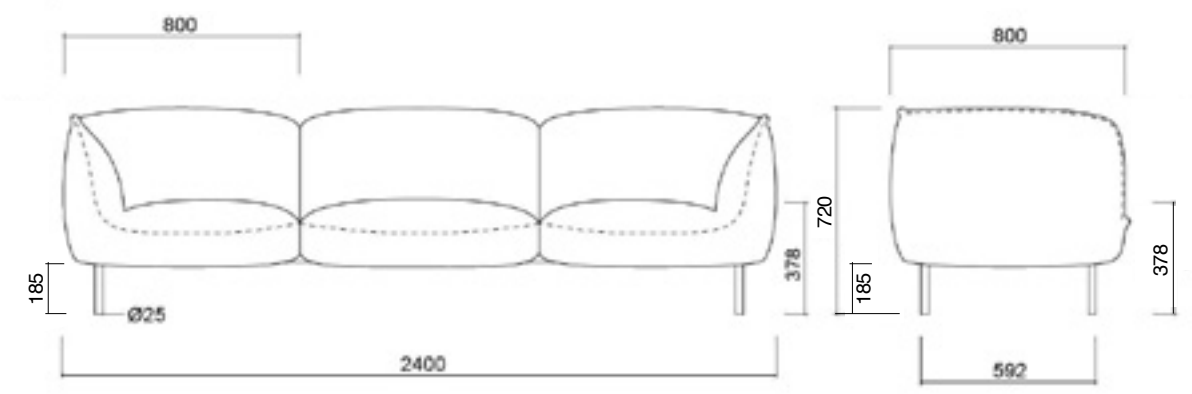

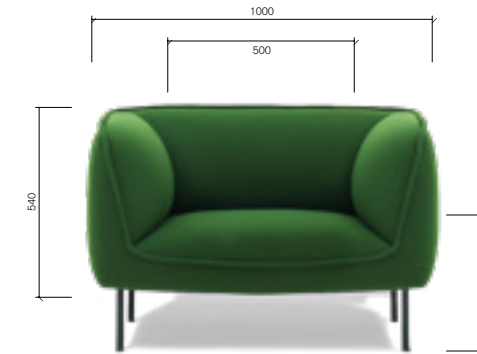
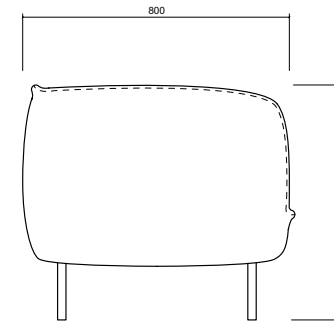

31 FA1

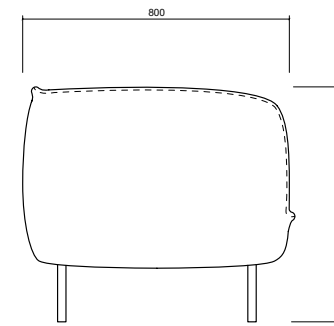

31 FA2

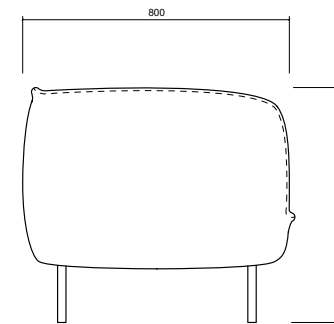

31 FA3



HUG

This is a chair composed for comfort, accessibility and function. The challenge has been in working with the pressed veneer to achieve bold curves which are comfortable yet retain the clean lines and strength of the material.

The Hug chair is perfect for every occasion, every person and every place. It can be suspended to a table by its frame, to facilitate cleaning and making everyday life a little simpler.

Design Jens Fager



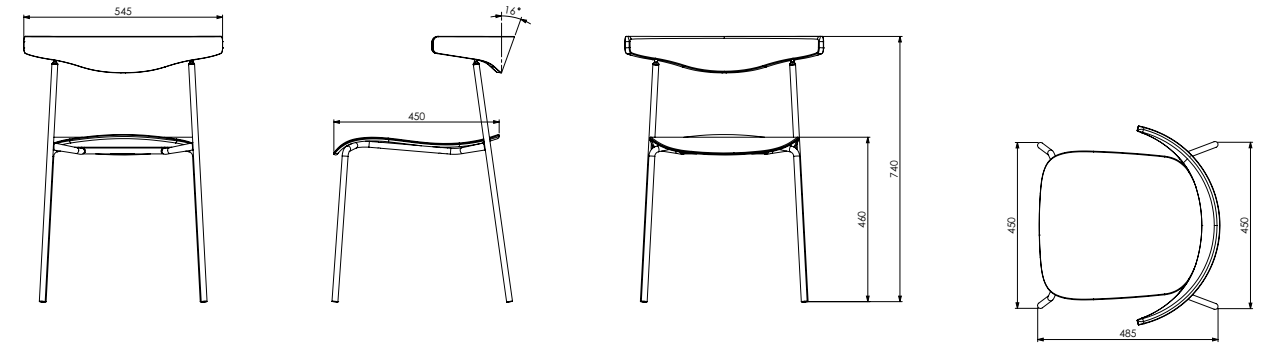

20693





LOOP

The idea was to create a simple and comfortable but stable and tough stool with a unique character. A stool for public environments with many people in movement and the need to cope with a great deal of wear.

You can vary the Loop Stool in terms of structure and thereby appearance, making it perfect for a range of touchdown spaces – from activity-based offices and lounges to bars and restaurants, bus and railway stations or airports. The Loop Stool is available in two heights and is suitable for a variety of different types of tables and environments.

The Loop Stool can be produced in conceptual monochrome, elegant leather upholstered with a leather-wrapped back support or in a sporty version with technical fabrics and soft cellular plastic in the back support.

Design TEA



LOOP

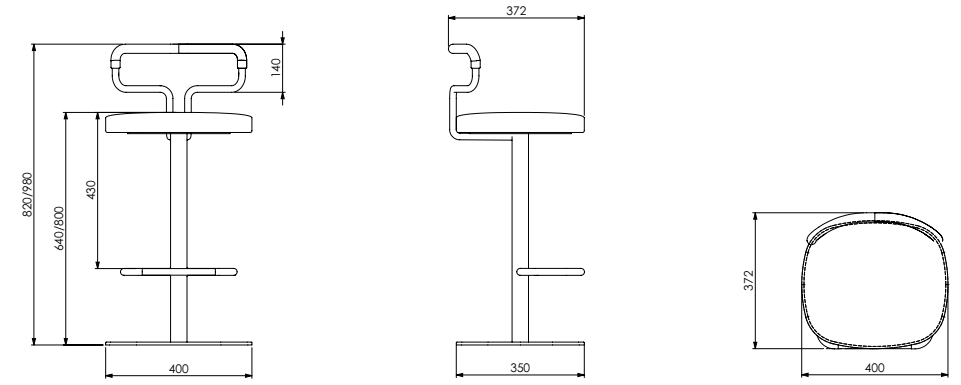

20694





NEAT

The Neat family consists of storage units and desks with an airy, streamlined appearance for modern offices.

The Neat desk is available in a number of models and variants that satisfy the majority of requirements and needs in a modern workplace.

Choose between fixed or adjustable work heights (sit 'n' stand) which give you the freedom to choose your working position.

The height adjustable desk is available in both single and double versions for system solutions.

There are many material combinations, offering you personalised interior decoration. Complement the desks with Neat sockets for electricity and data which are discreetly integrated into table tops and technical panels, providing an attractive finishing touch.





NEAT TABLE

A neat family with a graphic form. Neat is a family of work tables and storage units with streamlined and airy design.

The Neat Table series features a variety of sizes and functions catered to fit most of the requirements and needs of a modern workplace, including well-designed technology panels and Neat electrical and network sockets.

Design TEA





HiLo Single

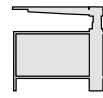
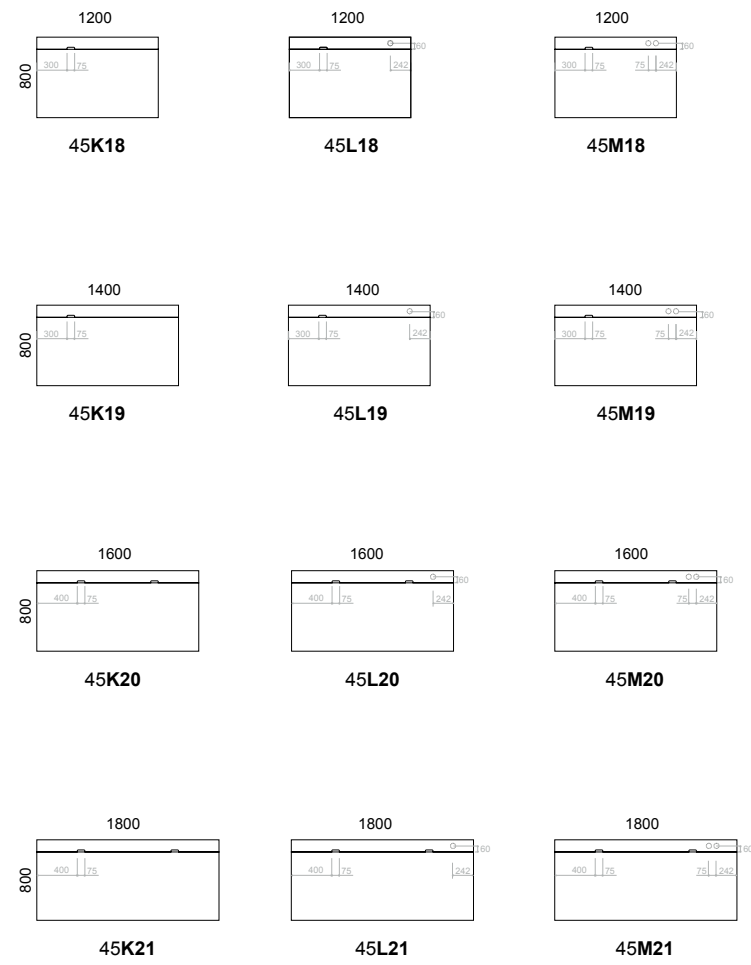

HiLo Dual

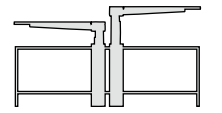
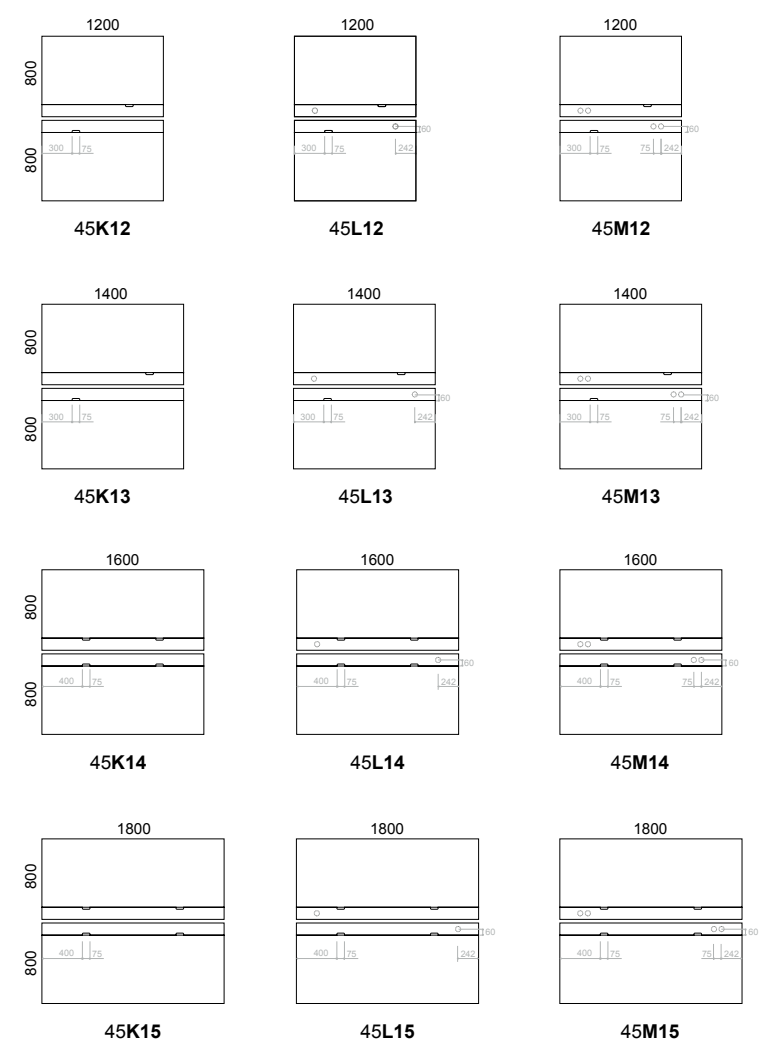

NEAT HiLo single table with table screen

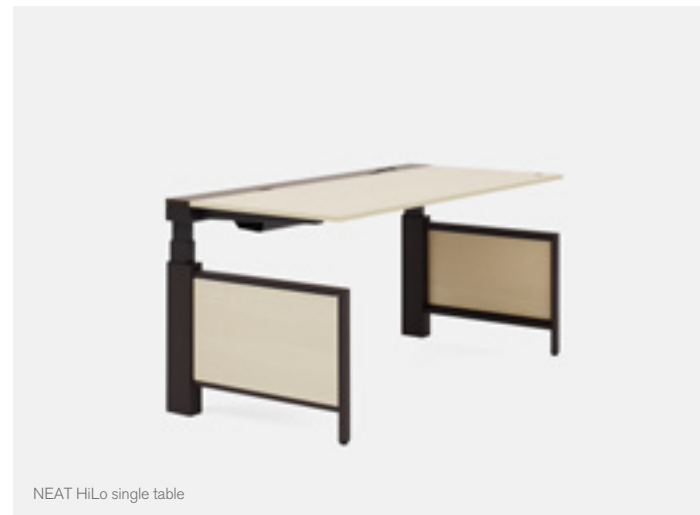

NEAT HiLo single table



NEAT TABLE HILO SINGLE / DUAL

SIT 'N' STAND INTEGRATED TOWER



NEAT TABLE HI



HiLo Single

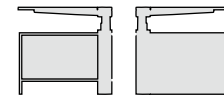
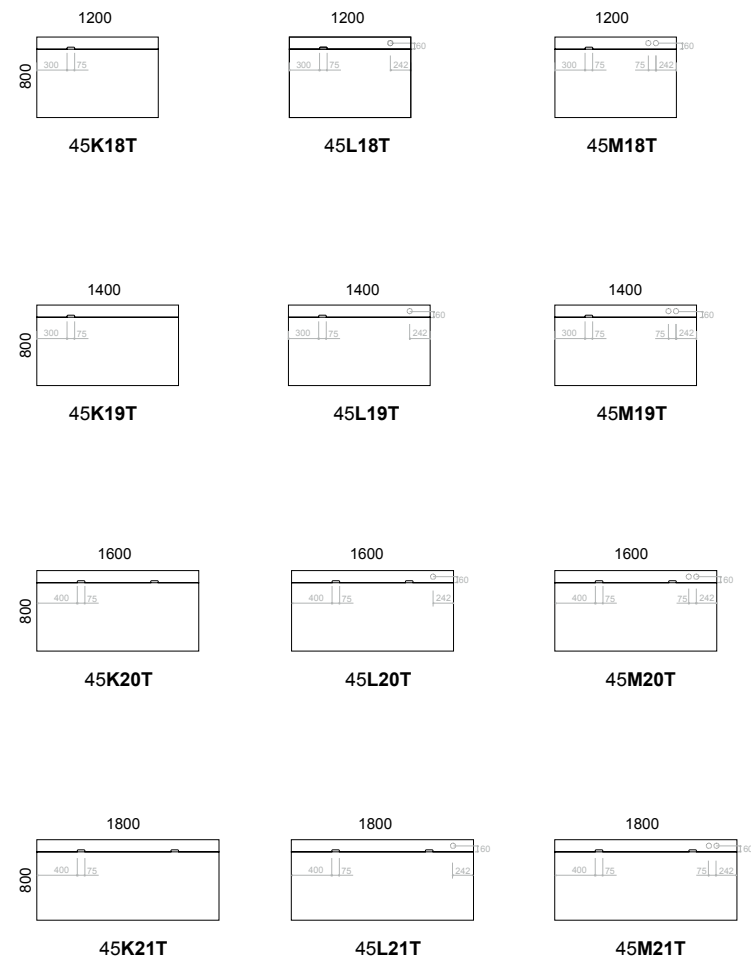

HI

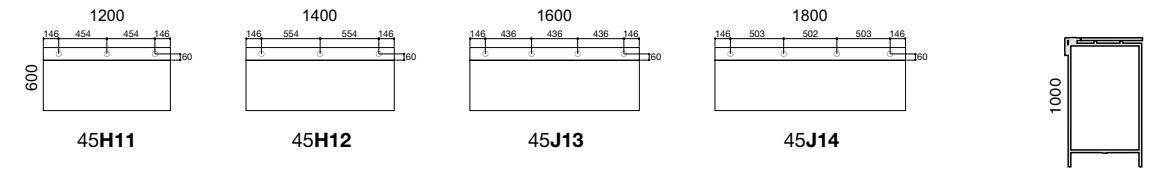

NEAT TABLE T-NET SINGLE



SIT 'N' STAND



T-Net

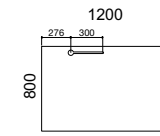

45N11

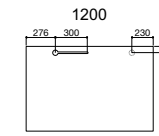

45P11

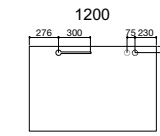

45Q11

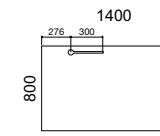
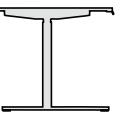

45N12

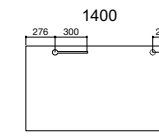

45P12

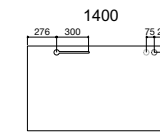

45Q12

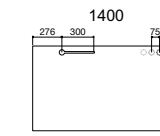

45R12

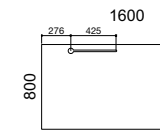

45N13

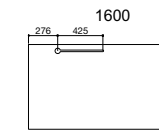

45P13

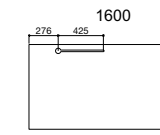

45Q13

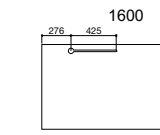

45R13

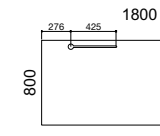

45N14

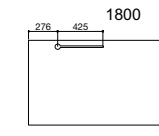

45P14

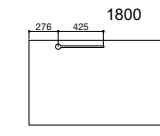

45Q14

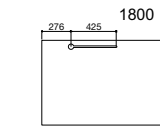

45R14

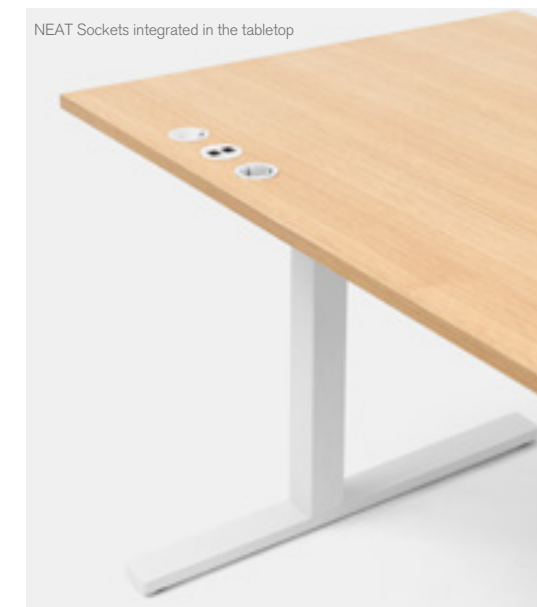

NEAT Sockets integrated in the tabletop



NEAT TABLE T-NET DUAL



SIT 'N' STAND

T-Net Dual

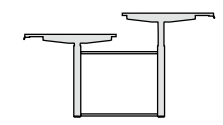
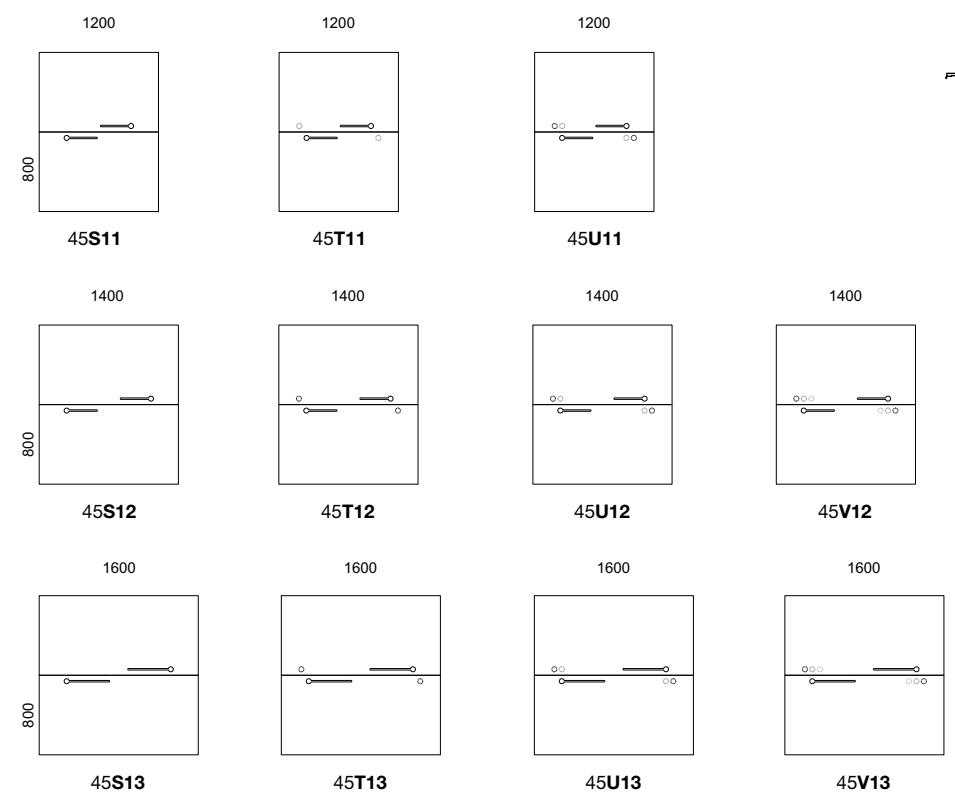





ACCESSORIES

Accessories that make daily work a bit smoother and more fun.
The Neat series offers many functional and stylish electrical accessories.
Contact us for more information.





NEAT Storage is available in width 800, 1200 and 1600. Height 2 x A4, 3 x A4, 4 x A4 and a 1 x A4 upper unit. Crest top in marble. Closed plinth or legs in metal.

NEAT STORAGE

By removing excess space from the cabinet, both in terms of height and depth, and using slender dimensions for the frame and doors, we have given Neat its own unique expression, which is greatly appreciated by architects and interior decorators.

Neat Storage units are as attractive from the back as the front and provide a plethora of variation opportunities. Match materials and colours according to your own desires. For example, you can choose different colours or veneers for the inside and outside of the frame. Doors and drawer inserts also enable creativity, as do the backs, which are available in Lacquer or with a textile covering for a more relaxed feel.

Design TEA

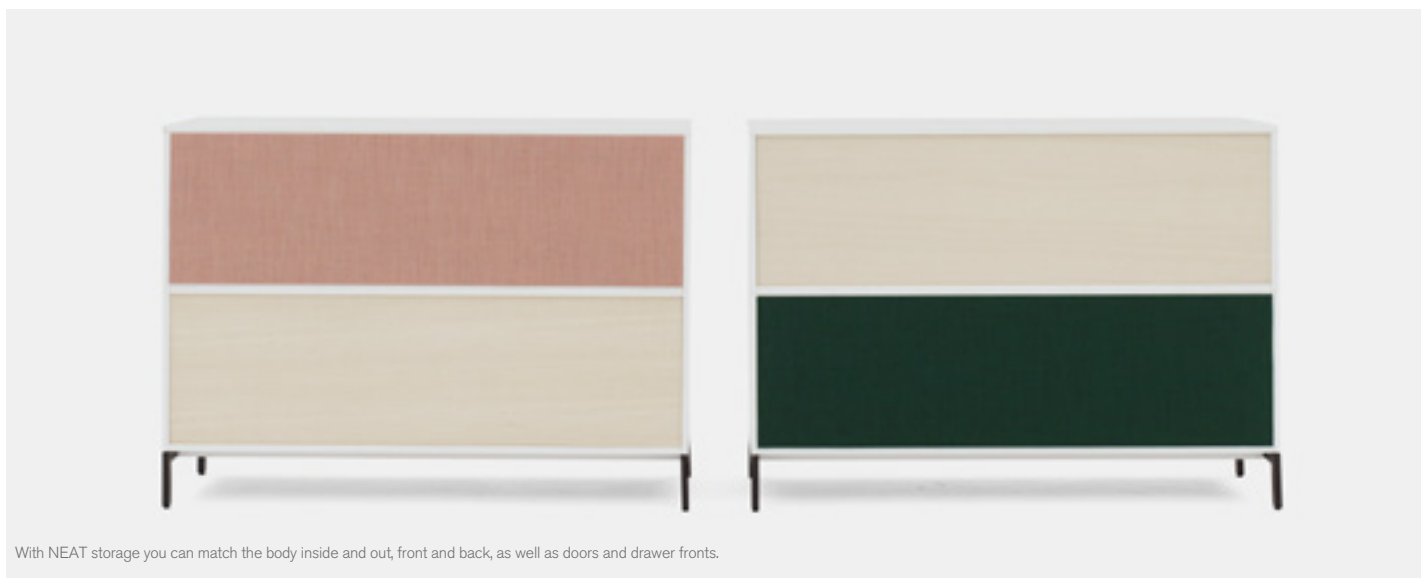

With NEAT storage you can match the body inside and out, front and back, as well as doors and drawer fronts.





Width 800, depth 385 mm

Body 2 x A4

Total height including plinth 800 mm alt. including legs 870 mm

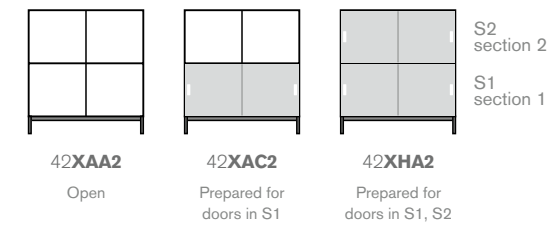

Body 3 x A4

Total height including plinth 1165 mm alt. including legs 1235 mm

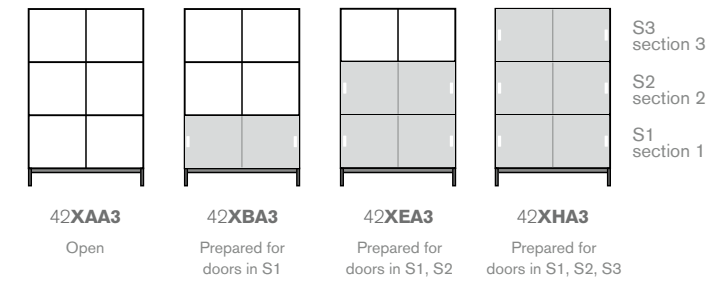

Body 4 x A4

Total height including plinth 1530 mm alt. including legs 1600 mm

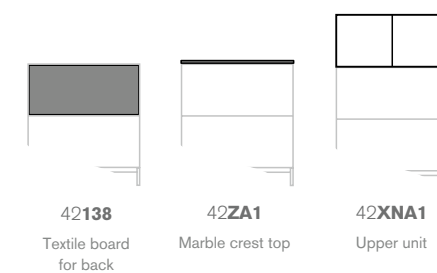
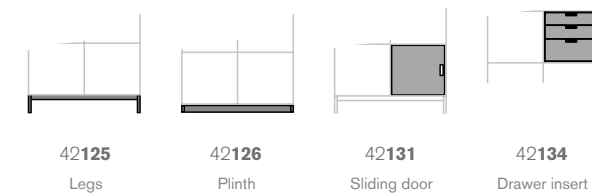
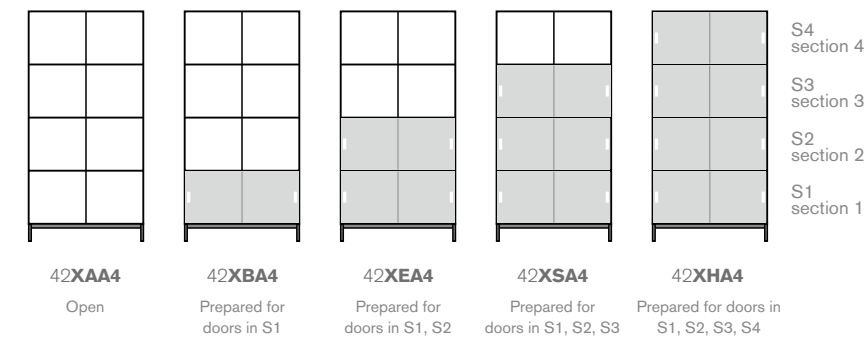

TECHNICAL SPECIFICATIONS

FRAME

Top panel, sides and bottom in 16 mm MDF, shelves in 22 mm MDF, centre panel in 8 mm MDF.

White lacquer (NCS S 0500-N).

Neat Green: White lacquer (NCS S 0500-N), Light grey (S 2500-N), Black (S 9000-N).

Veneer: Oak, Black stained veneer, White glazed ash.

UNDERCARRIAGE

Square profile legs, height 130 mm. White or black lacquer.

Closed plinth, height 60 mm. White lacquer

All frames have adjustable feet to compensate for uneven floors.

DOOR/BACK

Sliding door and back in 6 mm MDF (lacquered/veneered).

LACQUER

White (S 0500-N), Light grey (S 2500-N), Black (S 9000-N), Dark grey (S 7000-N), Petroleum (S 7020-B10G), Bay leaf green (S 4020-G30Y).

VENEER

Black stained veneer, White glazed ash, Oak.

Neat Green planter box

Lacquered sheet metal. Black, White, Dark Chocolate, Misty Grey

Neat Green trellis

Lacquered sheet metal. Black, White, Dark Chocolate, Misty Grey



Width 1200, depth 385 mm

Body 2 x A4

Total height including plinth 800 mm alt. including legs 870 mm

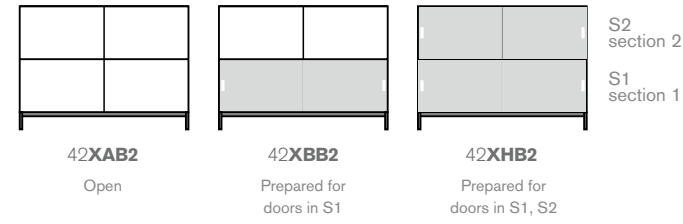

Body 3 x A4

Total height including plinth 1165 mm alt. including legs 1235 mm

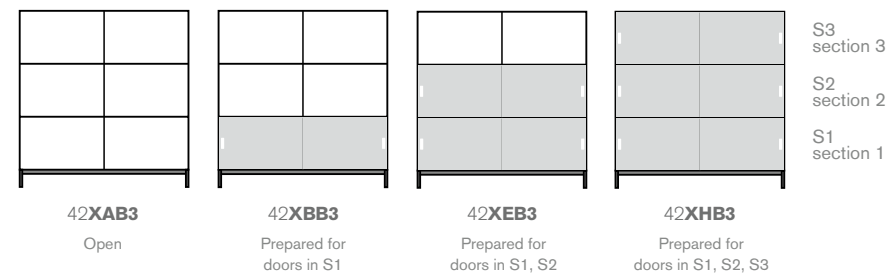

Body 4 x A4

Total height including plinth 1530 mm alt. including legs 1600 mm

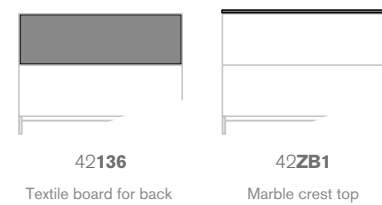
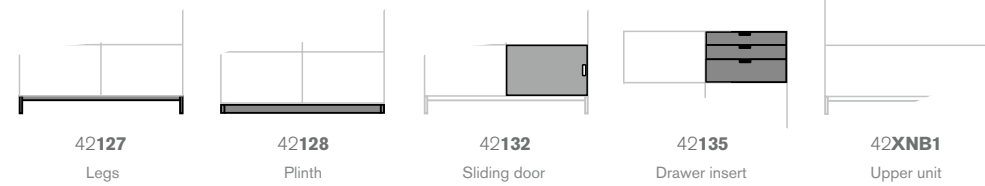
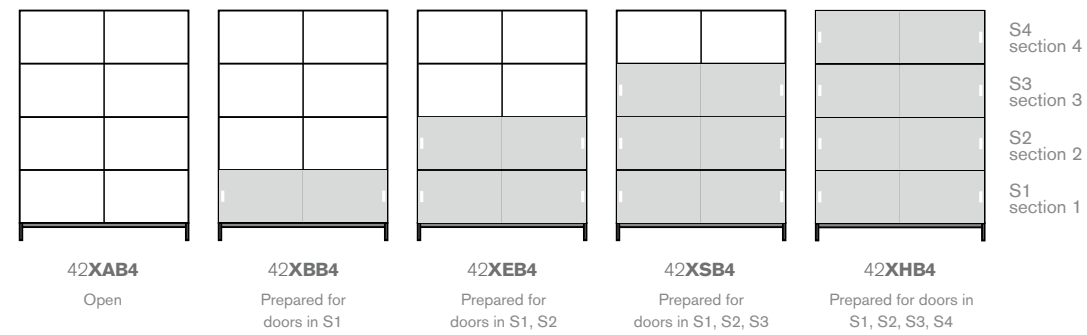

Width 1600, depth 385 mm

Body 2 x A4

Total height including plinth 800 mm alt. including legs 870 mm

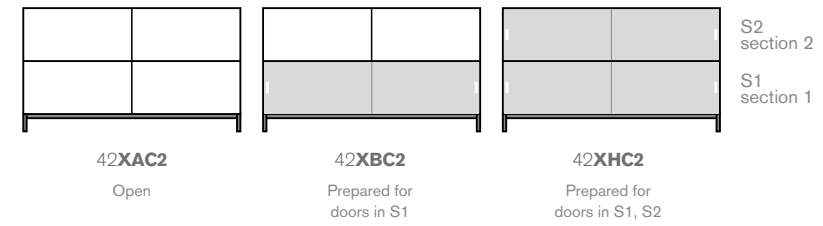

Body 3 x A4

Total height including plinth 1165 mm alt. including legs 1235 mm

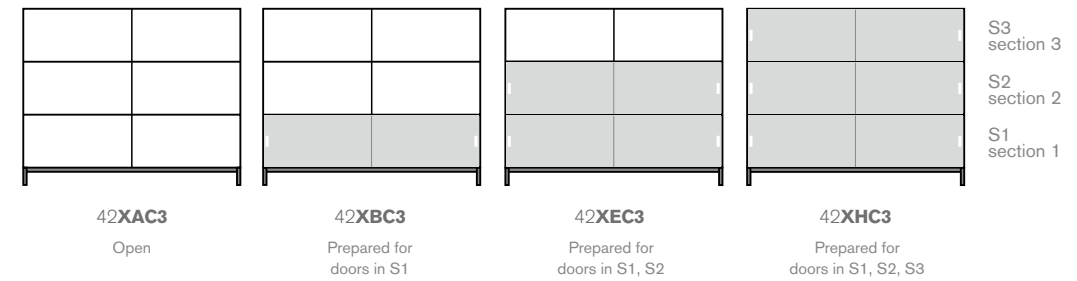

Body 4 x A4

Total height including plinth 1530 mm alt. including legs 1600 mm

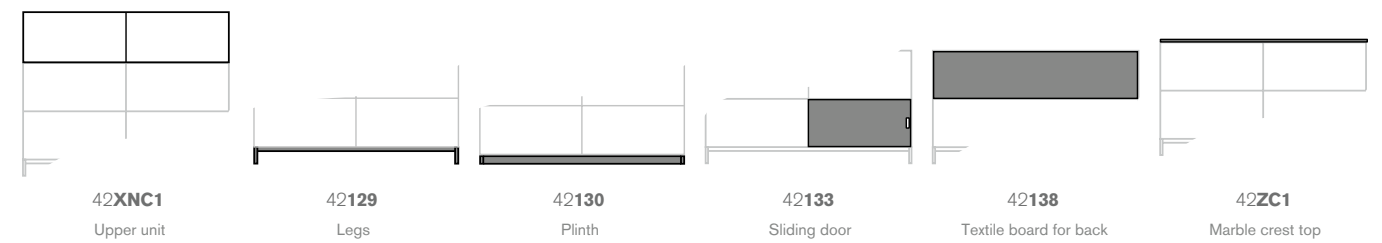
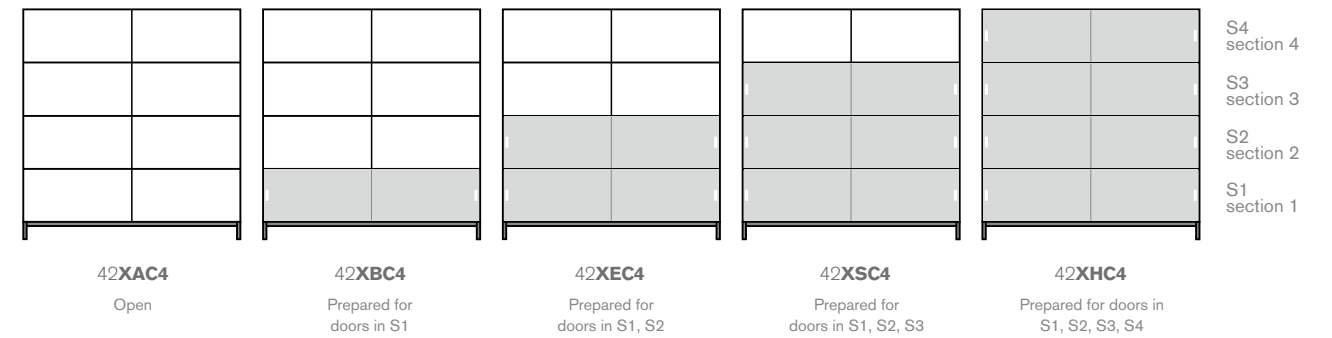

Wardrobe

Width 600 mm, depth 385 mm

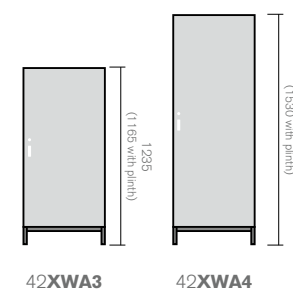

Tower

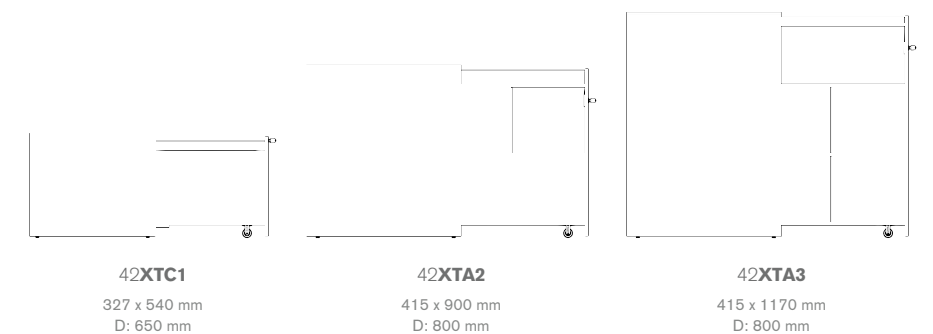

NEAT COMMAND

– One card, many possibilities.



ACCESS

Access to the parking garage, entrance, department, private lockers as well as technical equipment such as printers and projectors.

REGISTER

Register lunch purchases, vending machine purchases etc. and deduct the cost directly from the employees' salaries.

RESERVATION

Book storage lockers, workplaces, conference rooms etc.

CONTROL

Control lighting etc. so that it's only on during working hours when the workplace is staffed.

TECHNOLOGY

NEAT Command uses proven RFID technology (Radio-frequency identification) and the software is developed and made in Sweden. In daily life you run into RFID in for example bus passes, ski passes, shop alarms, ID-cards etc. Regardless if you want to work with EM 125 kHz or Mifare, NEAT Command delivers.

ADAPTABILITY

Your needs decides the solution and every project is unique. Use already existing access control systems and complement with locking of furniture etc. or create a completely new system. Brief us of your needs and we'll create the best solution together.





800 mm

1200 mm

1600 mm

UPPER UNIT

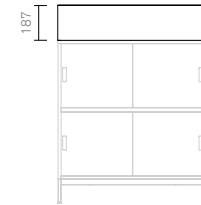

42VA0

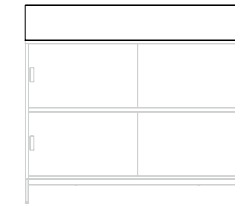

42VB0

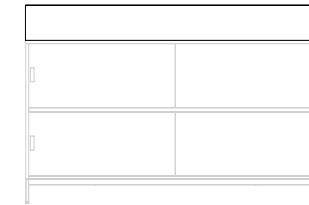

42VC0



FLOOR STANDING WITH TRELLIS

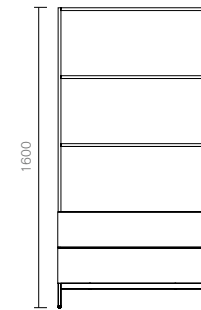

42VA1

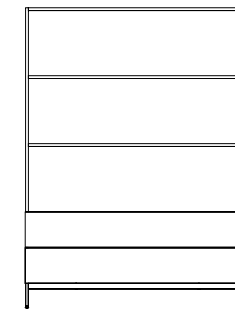

42VB1

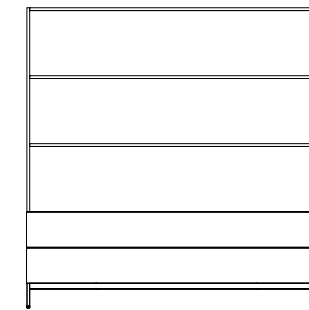

42VC1



FLOOR STANDING WITHOUT TRELLIS

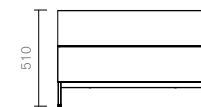

42VA1

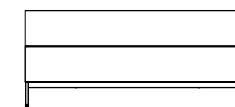

42VB1

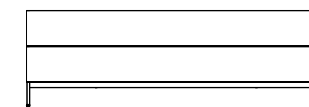

42VC1



FLOOR STANDING WITH TRELLIS AND WIRE MESH

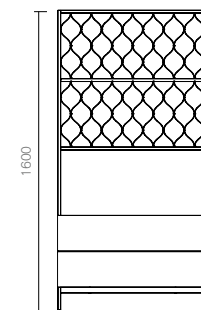

42VA1

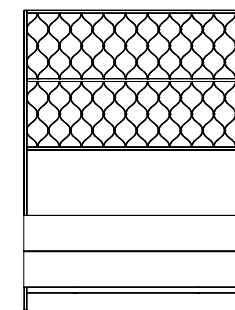

42VB1

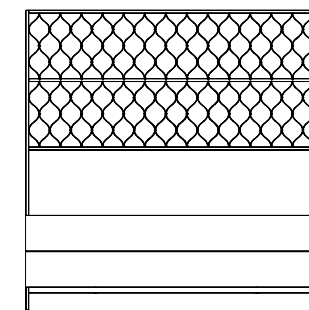

42VC1





THOMAS ERIKSSON ARCHITECTS

With the core of a strong desire to explore the intersection of art and science, Thomas Eriksson Architects are designing furniture, that communicate and builds identity with Scandinavian tonality.





OPUS LIGHT

Makes your decision easy, Opus Sit 'n' Stand offer less choices and the same high and dependable quality.

Attn. On my.edsyn.com and in the price list, the art. no. for table tops start with 06 and Sit'n'Stand with 08

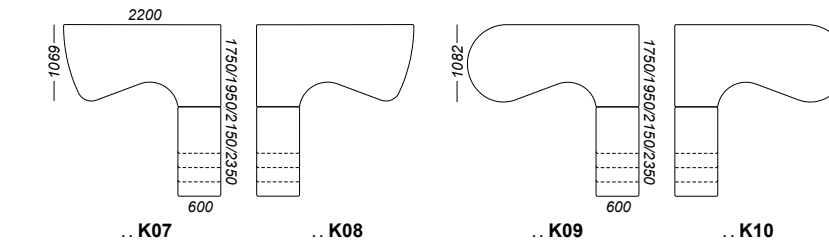
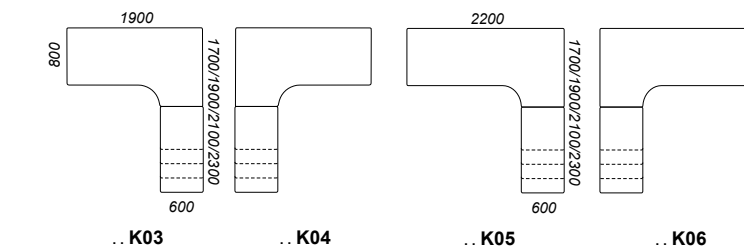
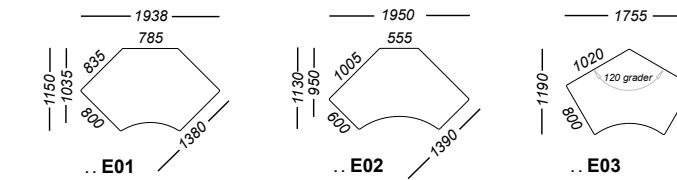
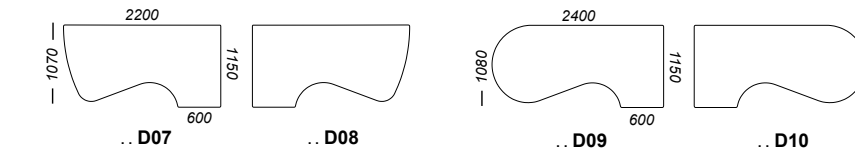
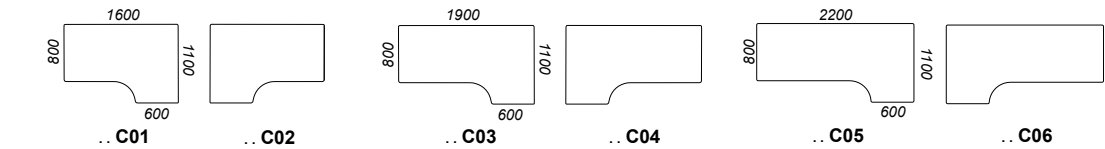
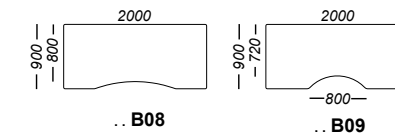
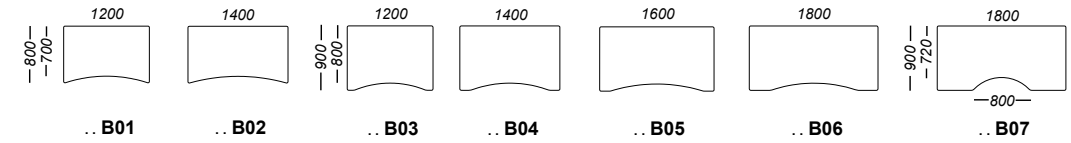
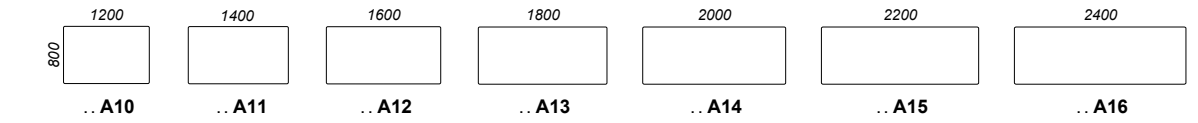

Opus light (2 Legs) 08404N



Opus light (3 Legs) 08405

FOOT



TECHNICAL SPECIFICATION

Beamless electrical stand with rectangular leg profile. Flexiframe function:

Height-adjustment with push button.

2 Legs adjustable width: 1150-1740 mm.

3 Legs adjustable width (main tabletop): 1740-2150 mm.

Adjustable depth (side tabletop incl. main tabletop): 1540-2130 mm.

AVAILABLE IN TWO DIFFERENT HEIGHT INTERVALS

675-1175 mm, exc. table top (2-piece telescopic/leg).

605-1265 mm, exc. table top (3-piece telescopic/leg).

The electrical stand can accept approximately 100 kg of evenly distributed load (table top included).

Only one version of foot, Opus Light foot.

Without attachment for accessories.

* Opus worktable in ash, oak, beech or laminate. With powder coated stand.



PART

The room-dividing storage system, with a back side as attractive as its front. To give structure to the open plan office, it has generous proportions. Choose between open shelves and sliding doors.

The Part family has many options such as lockable doors, safe deposit boxes, drawer fittings, wheels or closed wooden plinths etc.

Design Anders Ekegren



Sideboard sliding doors and drawers / depth 421 mm

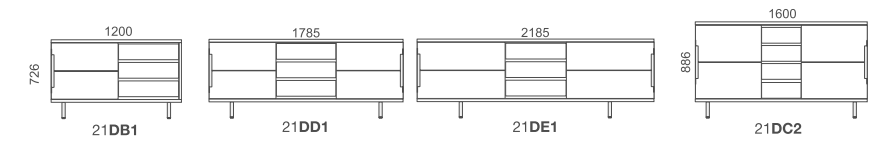

Sliding doors integrated wardrobe / depth 421 mm

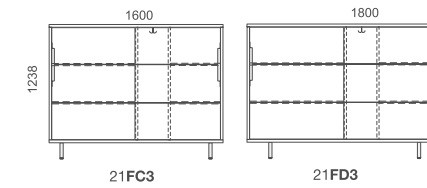

Sliding doors / depth 600 mm

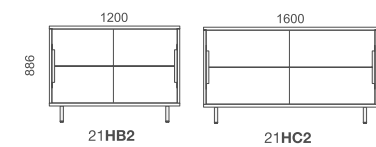

Sliding doors wall mounted / depth 350 mm

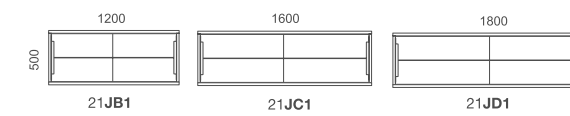

Wardrobe / depth 421 mm

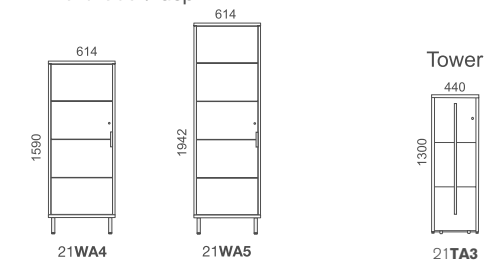

Storages with legs (150 mm) can also be obtained with a closed plinth

The height of the cabinets above applies to storage on legs. The height with closed plinth is 50 mm lower.

Drawers insert

W 404 H 328 D 344
Does not fit storages in width 814 mm



21 Z01

Value box

For storages in depth 421 mm



21 Z02

Adjustable file box

Without anti-tilt, adjustable width.
H 90, D 340. Colour: Silver



10 678 40040 For inner width: 300-460 mm
10 678 40080 For inner width: 540-910 mm





Open / depth 421 mm

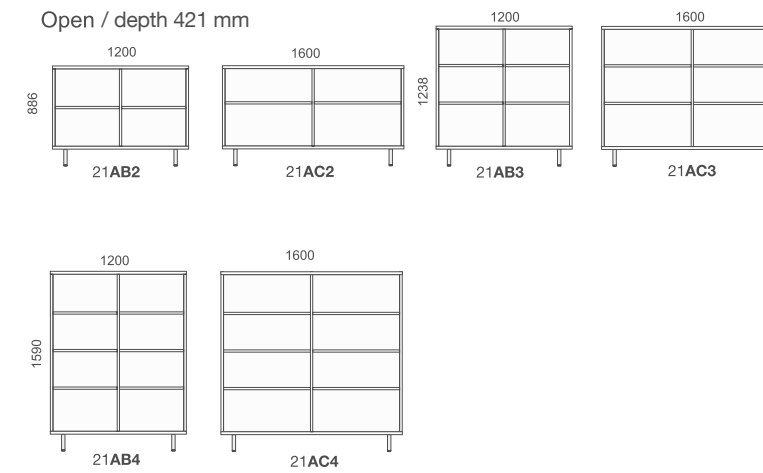

Sliding doors / depth 421 mm

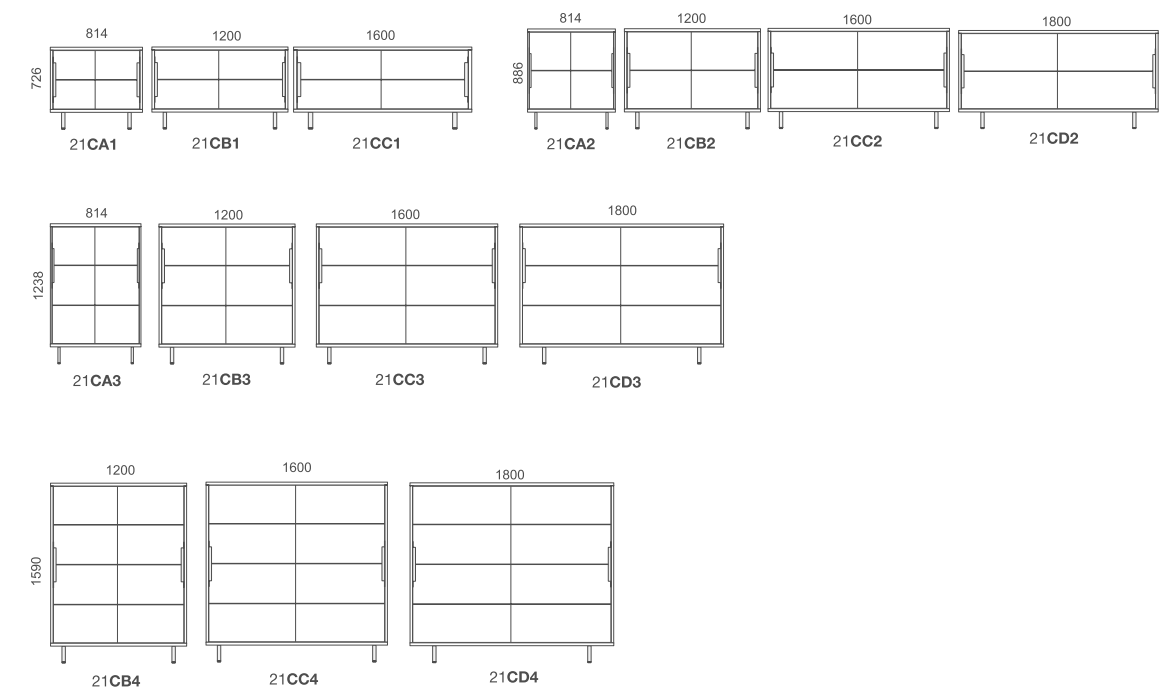

Storages with legs (150 mm) can also be obtained with a closed plinth

The height of the cabinets above applies to storage on legs. The height with closed plinth is 50 mm lower.

TECHNICAL SPECIFICATIONS

SHELVES

The shelves fulfill loading requirements according to standards.

Plinths for the storage units are available with legs including plinth frames in metal or with closed plinths in fibreboard. All plinth solutions have adjustable feet.

FRAME

The frame is constructed of chipboard or MDF in 19, 22 and 25 mm with a birch or oak veneer or white topcoat. The veneer is 0.6 mm thick. Edge strip in wood or ABS. Some edges have open flat MDF edges, including the fronts of the drawer inserts. Backs in 10 mm MDF.

Part can be delivered as a "knock down" version to order.



PIECE

Piece is a series of furniture for creative work and meetings. The Piece table is a media-ready table perfect for spontaneous meetings with or without laptops, phones and iPads. Piece Serve is a stylish recessed holder that are easily placed in the cut-out for the cable management.

Piece wall-mounted wardrobe is easy to position and creates an airy feeling wherever it is in the office.



PIECE TABLE

All tables have legs, but few have as much attitude as Piece.

The 730, 900 and 1060 mm heights facilitate a wide range of working situations.

From sitting work to sitting or standing meetings. Planned or spontaneous.

Strict or creative.

For computer work, the Piece table is available with cable holes and cable trays to manage all of that unsightly but necessary cabling. Choose between

round and rectangular Piece tables. The latter can be made into

as long a table as you require.

Another smart accessory is our new Piece Serve, a recessed holder that you can place right in the middle of the table. Use it as a storage tray by day, as an ice bucket for your evening celebration or even as a planter for fresh herbs

that can add that finishing touch to your lunch hour.

Design TEA



RECTANGULAR

Split tabletops

Height 730 mm, 900 mm alt. 1060 mm

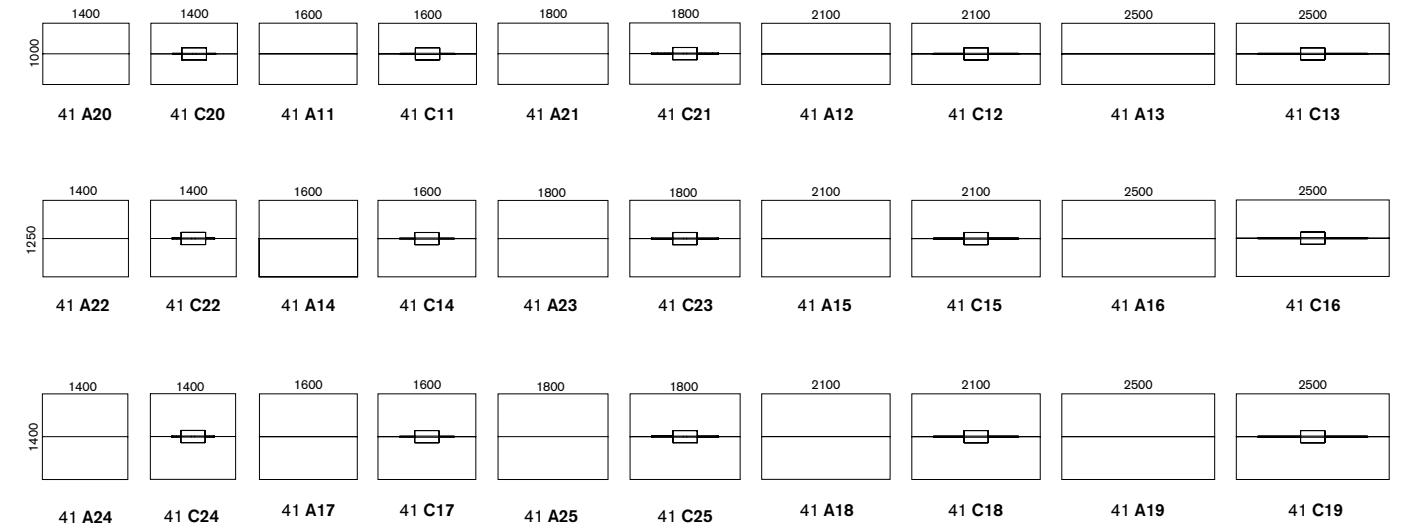

Whole tabletops

Height 730 mm, 900 mm alt. 1060 mm

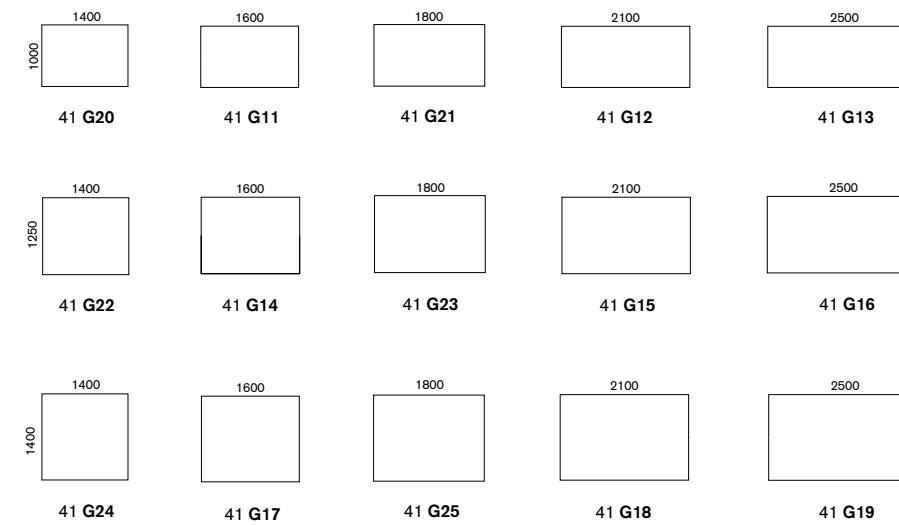

Piece V

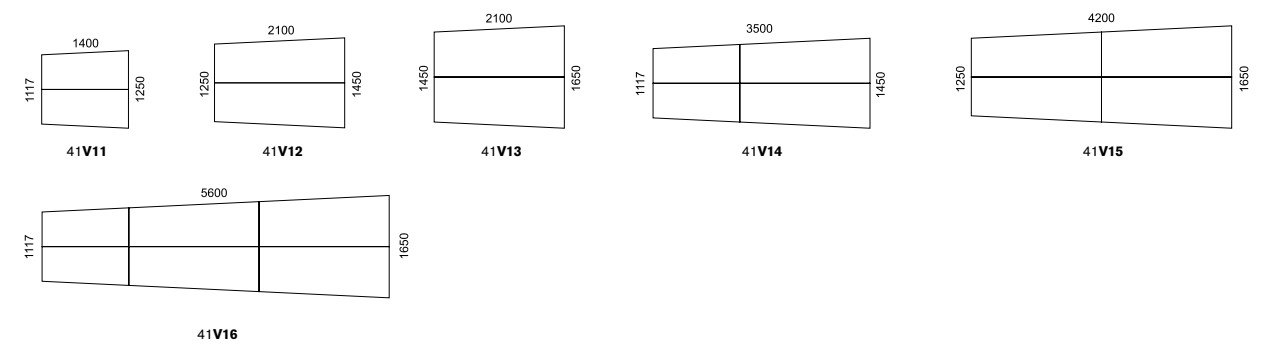

TECHNICAL SPECIFICATION

TABLE TOPS

The table tops are manufactured as 19 mm MDF with straight edges.
Available in a variety of surface materials such as veneer, desktop and high-pressure laminate.

STAND

Rectangular 80x20 mm profile in white, black lacquer, Dark chocolate and Misty grey. The table is available in 730, 900 and 1060 mm heights (inc. top).

PIECE SERVE

Lacquered sheet metal. White (S 0500-N), Black (S 9000-N), Dark Chocolate, Misty Grey



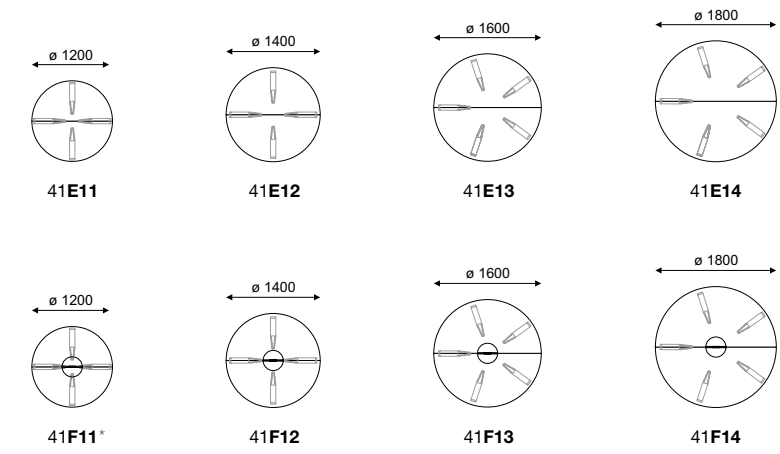

**Not available in height 1060 mm*

TECHNICAL SPECIFICATION

TABLE TOPS

The table tops are manufactured as 19 mm MDF with straight edges. Available in a variety of surface materials such as veneer, desktop and high-pressure laminate. The table tops are always two-piece.

STAND

Rectangular 80x20 mm profile in white lacquer. The table is available in 730, 900 and 1060 mm heights (incl. top). Stand is available in white, black, Dark chocolate and Misty Grey.



PIECE SERVE
RECTANGULAR



PIECE SERVE
ROUND





PIECE HANGER

A slim and smart wall mounted clothes rack/wardrobe with a hat rack.

The front is available as a magnetic whiteboard, mirror, laminate, veneer or as painted surface. Add a shoe-rack and a clothes hook for more function.



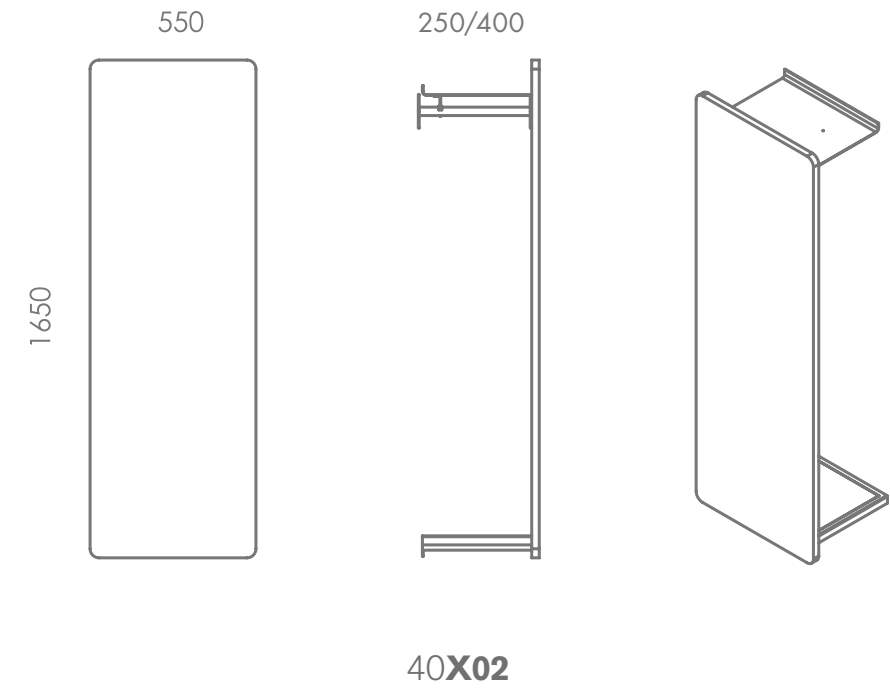

PIECE Hanger, oak veneer. PIECE Hanger, whiteboard (other colours than white is optional).



RESOLVE

A room within the room. Resolve makes possible seclusion and undisturbed conversations in open plan offices and public environments. The sofa and armchair have generous widths – so that you can have your laptop and other work material alongside you if you want to work.

With its characteristic form and upholstery,
Resolve is a future classic.

Design Dan Ithreborn





Seat height 400 mm



31670

31671



31672

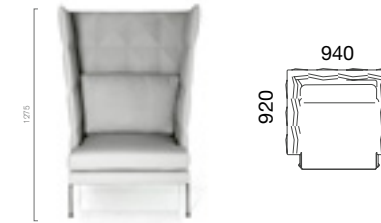

31649



31646



31647



Pillow
31645

Fabric requirement:
0,7m (fabric width 140/150 cm)

TECHNICAL SPECIFICATION

Back of wood / polyether.
Seat in wood with Nozag / polyether with fiber padding.
Back cushions in feather / down.

Steel frame in chrome or white lacquer.
Upholstered laminated fabric Samar.



RESOLVE PLAY

Create a room within the room, with Resolve Play you can easily put two sofas together. The key is that the edges of the partition wall and the sofa can be connected using Velcro. Create a small conference room by adding an AV-prepared partition wall.

Resolve Play can be dressed in a number of fabrics and variants, even with different fabrics on the frame, seat and cushions.

Both the one and two-seater versions are generously broad, which creates space for laptops and other equipment.

Design by Dan Ihreborn.



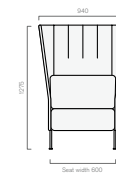

31GC

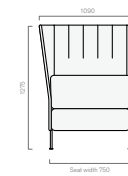

31GB

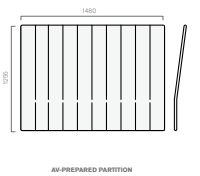
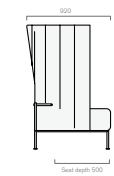

AV-PREPARED PARTITION
31GE0
31GET

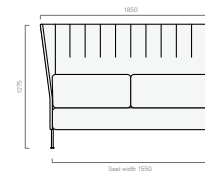

31GA

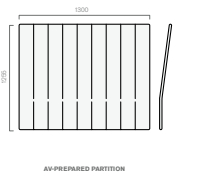
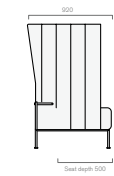

AV-PREPARED PARTITION
31GD0
31GDT

TECHNICAL SPECIFICATION

Resolve Play can be upholstered in many different fabrics and favourably even use different fabrics for the frame and the seat and cushions.
With the help of a partition wall, which can be obtained AV-prepared, two sofas can form a small conference room.
Connecting the partition is done with velcro (which is specified when ordering).



SHELVING SYSTEM

The shelf system is a rational storage method. Screw the support strip in place and hang up the rails. Quick and easy.

Recommended when you want to change the fittings as your needs alter. In combination with our shelves, wall-mounted cabinets, noticeboards etc. you obtain a complete, flexible system for wall-mounted storage.



Wall-mounted rail 1670 mm 13AA1
Incl. cover strip. White, black or silver laquer



Wall-mounted rail 2800 mm 13AB1
Incl. cover strip. White, black or silver laquer



Hanging rail 1237 mm 13BA1
White, black or silver laquer



Hanging rail 1950 mm 13BB1
White, black or silver laquer



Shelf 803x300 mm 13CA1
Shelf with core in chipboard (for max load 30 kg), or melamine-faced chipboard (for maximum load 60 kg).



Shelf 803x416 mm 13CA2
Shelf with core in chipboard (for max load 30 kg), or melamine-faced chipboard (for maximum load 60 kg).



Shelf 803x600 mm 13CA3
Shelf with core in chipboard (for max load 30 kg), or melamine-faced chipboard (for maximum load 60 kg).



Magazine shelf 803x300 mm 13CD1
Shelf in plexiglass with 30° inclined console. Height of the edge in the front 40 mm.



Bottom shelf 13CE1
Bottom shelf for use by Reflect upper unit 10NB1 or 10SB1 in shelving. Covered gable.



Assembly kit for wall-installed rail 13Z01
For drywall incl 5 pcs molly fittings. Bearing strip 2800 mm needs 2 installation kits.



Supporting foot for hanging rail 13Z02
Used as extra support when needed. Adjustable +15 mm. Handles up to 15 mm deep and 105 mm high baseboards.



Accessories hook for wall-mounted rail 13Z03
Hooked into the bearing strips lower track. Height 40 mm.



Textile board 13Z04
Textile board hung in the hanging rails for shelving systems. Width 790 mm, height 1235 mm.



Notice-board 13Z05
Board of cork with a pen shelf in metal. Width 800 mm, height 620 mm.



TECHNICAL SPECIFICATIONS

Shelf 13CA1, 13CA2 and 13CA3 is 803 mm wide and is available in 300, 416 and 600 mm depths.

Newspaper shelf art. no. 13CD1 is manufactured in curved plexiglas.

Textile sheet 13Z04 is manufactured in 10 mm board and 7 mm of sound absorbing material, which is upholstered with one of our standard fabrics for screens or with the customer's own fabric. For the customer's own fabric, the quantities are: monochrome fabric, 1.5m of width 130 cm; monochrome

fabric, 0.9 m of width 150 cm.

Bulletin board 13Z05 consists of a cork board mounted on fibreboard with an edge strip, and a sheet metal pen shelf.

Other accessories are an accessory hook and folder support 10626.

The above fittings, together with rails and shelf ends, are powder coated and available in white, black or silver laquer.

Shelves are manufactured from laminate or veneered chipboard. The veneer is knife cut from beech or birch and natural coloured. Oak is available as an option. The veneer is approx. 0.6 mm thick. Shelves in 300 mm and 416 mm depth are veneered on both sides. Balancing foil is glued to the underside of the 600 mm thick shelf/work surface. The edges of the shelves and cabinets are flat and edged with wood or ABS edging strip. The edges on the slotted screen are flat MDF edging. All edges have the same strength.



SOLID TABLE TOP











A solid wood table top produced in full stave, which gives it a substantial and elegant expression. The top has a balanced edge that is easy on both the hand and the eye. A groove on the underside offers a comfortable grip that makes it easier to move the table.

Solid Table Top comes in many different sizes and fits on our table legs Cone Table and Feather's pillar stand. Choose between Ash and Oak Natural, which are treated with our carefully selected varnish to preserve the sense of wooden structure and its natural shades.

"We are proud of our new Solid Table Top! Edsbyn's and my love for solid wood has now become a reality." – Jens Fager





 43A11 46A11 L: 520 W: 400 H: 370/460/530/600/730	 43A13 46A13 L: 600 W: 700 H: 370/460/730/900/1060	 43A16 46A16 L: 600 W: 800 H: 370/460/730/900/1060	 43A17 46A17 L: 800 W: 800 H: 370/460/730/900/1060
 43C11 46C11 L: 550 W: 450 H: 370/460/530/600/730	 43C12 46C12 L: 620 W: 530 H: 370/460/530/600/730	 43C13 46C13 L: 600 W: 600 H: 370/460/530/600/730	 43C16 46C16 L: 800 W: 800 H: 370/460/730/900/1060
 43B11 46B11 Ø: 620 H: 370/460/530/600/730	 43B12 46B12 Ø: 700 H: 370/460/730/900/1060	 43B13 46B13 Ø: 900 H: 370/460/730/900/1060	





ZIV

Ziv is an extremely comfortable and versatile chair with an »armchair feel«.

The elegant form of the shell with its precise seams give the chair character, and Ziv works just as well in the home as the office.

Ziv is available with a number of different frames. Choose between Ziv with or without swivel function, wheels (not swivel version), runners (including 2-seater), rotatable pillar (return mechanism) or wooden legs.





Fixed tripod



20590

Swivel



20591

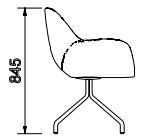
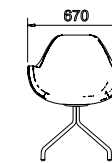
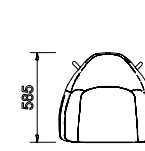

Wheels



20592

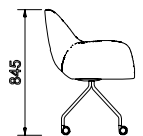
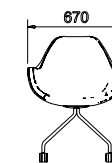
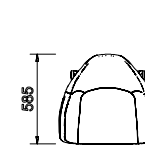

With column



20587

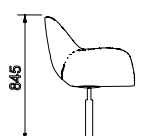
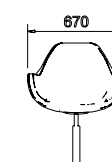
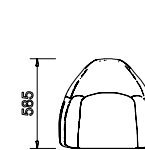

Wooden legs



20584

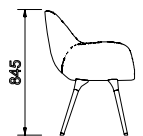
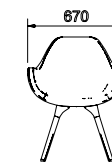
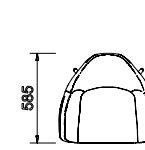

Runners



20586

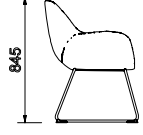
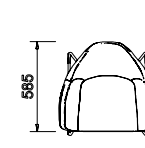

Ziv 2 seater sofa



20585

Height: 850, width: 1170, depth: 620 mm.
Seat height: 450, seat width: 940, seat depth: 460 mm.
Height armrest: 640 mm.

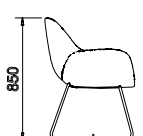
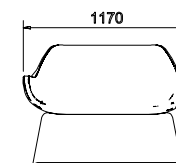
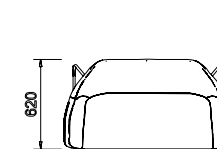

TECHNICAL SPECIFICATION

Ziv is available in following fabrics: Evo, Event, Europost 2, Fame, Gaja Classic, Luna 2, Messenger 4, Divina MD, Divina Melange 2, Steelcut Trio 2, Tweed, Remix. White stitching at black fabric (black sticking is available at request),

black side stitch as standard in other colours.
Height: 845, width: 670, depth: 585 mm. Seat height: 455, seat width: 430, seat depth: 460 mm. Height armrests: 645 mm.



ACCESSORIES

In our range of accessories for the table, we can offer the most in cable management, computer management and display management.

We can also supply other variants than those found in the price list, please contact us for more information.



Wire cable tray
Light and flexible construction. Installation under the table top. Black, silver or white laquer.

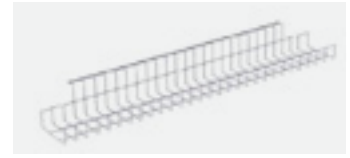

Cable tray Flexi
Assemble directly to the table top. Adjustable in length between 930-1600 mm. Width 145 mm, height 155 mm (including mount). Pivoting on both sides, for easy access to cables and connectors.



Cable tray Halfpipe
Bowl-shaped cable tray in aluminum. Adjustable swivel function for easy access. Width 170 mm, height / depth of 80 mm. Black or silver laquer.



Cable Box
Ø 88 mm. For Ø 80 mm hole in the tabletop. With two lids for cable entry when choosing silver, white or black. With brush for cable entry when choosing chrome or silver with brush.



Bi-Box small
300x150 mm. For 286x135 mm cutout in the tabletop. Cable access and cable tray in one piece. Door can be opened in both directions. Soft closing function. Can be supplemented with Power-inlay (equipped) ordered separately.



Cable Port
90x90 mm. For Ø 80 mm hole in the tabletop. Front made of brushed steel. 1 power socket, 1 network, 1 HDMI and 1 USB (PC is required to operate USB). 1.5 meter cable.



Cable Box
Aluminium with brush. Ø 88 mm. For Ø80 mm hole in the tabletop.



Axessline Quickbox
The product's spring mechanism automatically opens the cover with the simple push of a button. 1 power, 2 USB-charger.



Waste sorting LiftSopi
Rotatable return & waste system that takes up little space under the desk. Height 390, width 255 mm. Waste bags are included. Can be supplemented with runner. Silver.



Laptop holder LiftLap
Holder for laptop that can be used both horizontally and vertically. Compatible with docking station. 320x355 mm. Colour silver. Slide channel (for sliding and swiveling holder) must be ordered separately.



Runner for LiftLap and LiftSopi 300mm
Runner for LiftLap and LiftSopi. Length: 300mm. Silver.



Runner for LiftLap and LiftSopi 400mm
Runner for LiftLap and LiftSopi. Length: 400mm. Silver.



Cable hatch with brush
Simple cable hatch in high-pressure laminate.

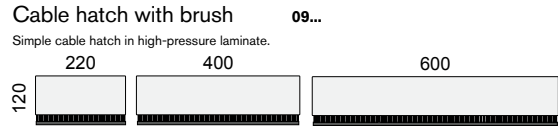

Axessline Qi-Charger
For Ø60 mm hole in tabletop.



Axessline Qi-Charger for UK sockets



Powerdot MICRO - 2 USB
For Ø30 mm hole in tabletop. Small and elegant USB charger.



Powerdot MICRO for UK sockets



Powerdot - Power, Data, USB
For Ø 80 mm hole in the tabletop. USB charger and Data jack in multi-level arrangement for hidden cable connectors. 1,5 meter power cord.



Powerdot for UK plugs

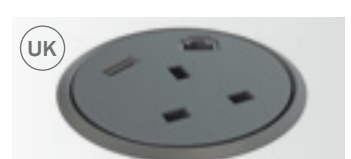

Powerdot - Power
For Ø80mm hole in tabletop. 1 power, 4 feed-throughs.



Powerdot for UK plugs



Axessline Desk 2 power, 2 USB
Assembles with clamp. 2 power, 2 USB-charger.



Axessline Desk for UK plugs



Powerdot MINI - Power
For Ø51 mm hole in tabletop. 1 power socket.



Powerdot MINI - USB
For Ø51 mm hole in tabletop. 2 USB for charging.



Powerbox
330x170 mm. For 286x135 mm cutout in the tabletop.



Axessline Desk 2 power
Assembles with clamp. 2 power, 2 data, 2 USB-charger.



Tabletop slim - 1 power, 2 USB
Hole in tabletop 64x161 mm.



Tabletop slim - 2 power
Hole in tabletop 64x161 mm.



Replicatorholder
Holder for Port replicator, optionally placed under or above the tabletop.



V4 Monitor arm
Assembles with clamp or with desk mount. Maximum load 8 kg.



V4 Twin Monitor arm
Assembles with clamp or with desk mount. Maximum load 8 kg per arm.



Self-closing braided tube
Available in both single and double variant. For mounting under tabletop and seatings.



Computer holder TurnIT - slide and turnable



LiftHolder Laptop holder
Functional storage for laptop.



Powerdot Bracket MINI
Available in both single and double variant. For mounting under tabletop and seatings.



Wireless charger
Wireless charger for installation in Ø80 mm hole in table top. 1 meter power cable.

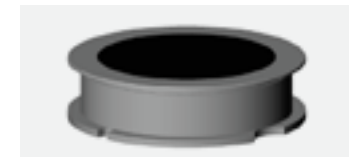

Computer holder LiftFix
For laying or standing PC. Incl: straps L. 1500 mm, 2 flat iron profiles, incl. 60 mm spacer.



Computer holder LiftFlex
Sliding runner with a convenient handle that can be rotated 360°, and with the rail for smooth and stable ride. With unique function for easy disassembly of the computer. Height Distance (height 65 mm) are included.



Computer holder QuickClick
Adjustable in width (50-135 mm) and height (225-435 mm). Can be supplemented with sled that makes computer holder rotatable.



USB charger (2xUSB)
USB 230V, 2xUSB-ports. Incl 1 cord (1 m).



Powerdot - Power, USB
For Ø80mm hole in tabletop. 1 power, 1 USB charger, 1 USB-C, 2 feed-throughs.



Powerdot MIDI - Power, USB
For Ø60mm hole in tabletop. 1 power, 1 USB charger. For UK plugs.



Monitor arm D-Zine
Gas lift arm which is easily adjustable in height and width. Vesa 75 and 100. Note: Check the monitor's weight so that the weight range is correct (1.5 to 8.5 kg). The arm comes with four installation options (desk clamp, through tables, edge mount and through cable entry). Can be supplemented with bracket for two monitors.



Bracket for two monitors
Maximum screen width 670 mm / monitor Silver, White or Black.



Laptop-holder TwistIT
Twistable and rotatable holder for laptops and small CPU's. Takes minimum space underneath the table. Can be used horizontally and vertically.



Drawer pull-out with lock
Pencil drawer with lock to be mounted under the desk, with the possibility to mount SetUp or CPU holder under this drawer.



LYKKE LED Lamp
Assembles with universal clamping bracket on table screen. Adjustable brightness and color temperature. Shuts down after 15 minutes in the absence of persons.



NIILA Lamp
Lamp with USB charger. Adjustable 5-step brightness control. Equipped with Eco-timer which automatically turns off the lamp after 4 hours usage. The lamp can be folded.



Pen compartment
In black plastic. Screwed under the tabletop or shelf. Width 380 Depth 370, height 30 mm (including expansions).



Pen Box rotatable
Rotatable box in plastic. Silver. Width 345 Depth 208 mm.



OCHNO Power Desktop
Type-C based docking station with unique features for the future flexible workplaces, up to 4 laptops/mobiles to one screen. 4 USB-A for connecting PC accessories, 1 Dual DisplayPort for connecting monitors.



OCHNO Socket USB-C
For Ø18 mm hole in tabletop. Small and smart socket with 3-i-1, charge, communication and docking/video (depends on which head unit). Head unit order separately.



Tidy tray Pennfact
Pen tray in plastic. 316x240 mm. Height 27 mm.

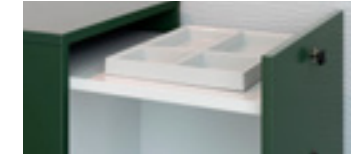

Hanging Cable tube
Stylish and practical cable tube. Up to 1252 mm in total height.



ACCESSORIES

FOR STORAGE

OPEN FILE BOX MAPPI A4

10678

On expansions, to be screwed on a shelf.
W 345, H 293, D 325.



ADJUSTABLE FILE BOX
(300-460 mm)

1067840040

Without anti-tilt, adjustable width.
W 300-460, H 90, D 340.



ADJUSTABLE FILE BOX
(540-810 mm)

1067840080

Without anti-tilt, adjustable width.
W 540-810, H 90, D 340.



TIDY TRAY

09Z01

Pen tray in plastic. 316x240 mm. Height 27 mm.



CLOTHES HOOK

10623

To mount on the gable of Access cabinet or shelf.



FILE SUPPORTING BOW

10626

Easy to mount on Access shelves to support files.
H 82, D 235.



PAPER

Accessories rail **09670x1080-09670x1180**
In aluminum. Suitable for mounting on Edsbyn table screen 548 and 549.
NOTE: Max load when mounted on table screen is 8 kg. Think of leverage.



Post compartment **09670x2001**
Width 330 mm, Depth 220 mm, Height 70 mm.
Total height 2 compartments: 190 mm, 3 compartments: 280 mm.

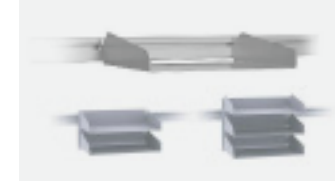

Bookend/binder shelf **09670x2004**
Measurements: 270x250x200 mm (width x depth x height)

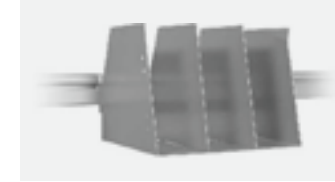

Pencil tray **09670x2002**
Measurements: 80x80x110 mm (width x depth x height)



Shelf / Pencil jar **09670x2003**
Measurements: 300x230x50 mm (width x depth x height).



Sorting compartment **09670x2005**
With three removable separators, tilting left / right.
Measurements: 330x230x250 mm (width x depth x height)



CONCEPTUM

Accessories toolbar rail **09678A088-09678A089**
Profile with unique mounting rail for external installation on table screen or integrated installation in table screen.



System shelf C5 **09678A047**
Storage for papers or other things. Detained simply on Conceptum toolbar rail. Width 222 mm, Depth 166 mm.

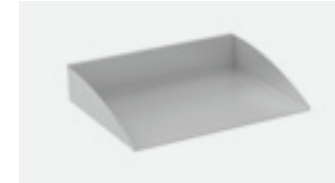

System shelf C4 **09678A048**
With three removable separators, tilting left / right.
Measurements: 330x230x250 mm (width x depth x height)



File & Catalogue holder **09678A049**
Holder for A4 Binders or publications.
Width 270 mm, Depth 255 mm, Height 200 mm.

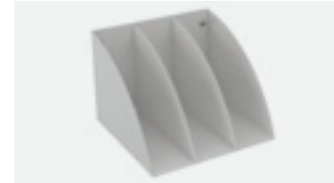

Pen & Gadget holder **09678A050**
Stores your pens, mobilephone etc.
Width 80 mm, Depth 50 mm, Height 116 mm.



In-Tray 3xC4 size **09678A051**
3 x C4 System shelves including console.
Width 324 mm, Depth 230 mm, Height 252 mm.

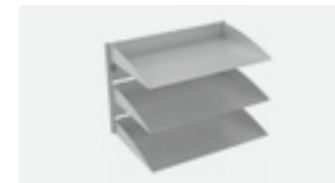

Laptop Pocket **09678A052**
Used to store a small laptop or notebook.
Width 280 mm, Depth 45 mm (inner depth 35 mm), Height 140 mm.



Headset holder **09678A054**
Wide and stable bracket for mounting on Conceptum rail.



Whiteboard **09678A055**
Magnetic whiteboard in C5 size. With Pen shelf.
Width 165 mm, Depth 36 mm, Height 225 mm.



Port Replicator holder **09678A053**
Supplied with Velcro bracket for flexible mounting of port replicator in the desired position. When mounting on an external rail, hold the holder vertically using the supplied spacer cover.

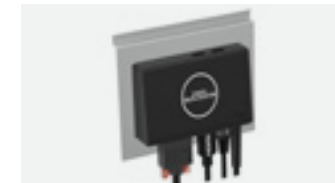

Monitor arm Stockholm **09678A056**
3 joints gas spring arm with 300 mm reach. Design with an ingenious quick-lock for the monitor. Monitor weight 3-8 kg. VESA 75/100.



Monitor arm Stockholm **09678A057**
3 joints gas spring arm with 300 mm reach. Design with an ingenious quick-lock for the monitor. Monitor weight 8-14 kg. VESA 75/100.



Monitor arm Stockholm - Duo-Bar **09678A052**
3 joints gas spring arm with 300 mm reach. With Duo-Bar for 2 monitors. Monitor weight (2x) 3.6-6 kg. VESA 75/100.

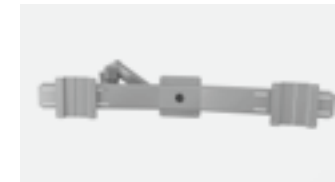

ACCESSORIES

FOR CONFERENCE TABLES



Cable tray conference 09677A019
Larger cable tray with foldable ends if you wishes to connect two or more cable trays. 660x268 mm. Height 140 mm.

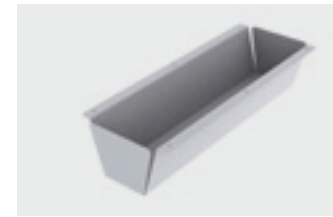

Bi-Box small 09677E
300x150 mm. For 286x135 mm cutout in the tabletop. Cable access and cable tray in one piece. Door can be opened in both directions. Soft closing function. Can be supplemented with Power-inlay (equipped) ordered separately.



Bi-Box large 09677G
605x150 mm. For 592x135 mm cutout in the tabletop. Cable access and cable tray in one piece. Door can be opened in both directions. Soft closing function. Can be supplemented with Power-inlay (equipped) ordered separately.



USB charger (2xUSB) 45Z21

USB 230V, 2xUSB-ports. Incl 1 cord (1 m).

USB cord (1 m) 45Z22



Cable hatch with brush 09...

Simple cable hatch in high-pressure laminate.

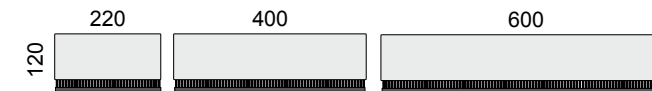

Cable hatch with brush 09...

Double cable hatch in high-pressure laminate.

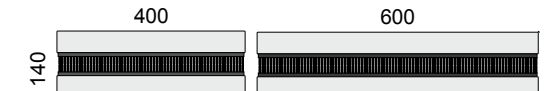

Axessline Qi-Charger 09678A068

For Ø60 mm hole in tabletop.



09678A084

Axessline Qi-Charger for UK sockets.



Powerdot MICRO - 2 USB 09678A074

For Ø30 mm hole in tabletop. Small and elegant USB charger.



09678A083

Powerdot MICRO for UK sockets.



Axessline Quickbox 09678A069

The product's spring mechanism automatically opens the cover with the simple push of a button. 1 power, 2 USB-charger.



Axessline Quickbox 09678A075

The product's spring mechanism automatically opens the cover with the simple push of a button. 2 power, 2 USB-charger, 2 data.



Powerdot Small 09678A066

Complete package for a stylish and functional solution to the conference table. Be supplemented with the desired Powerdot for Ø80 mm holes. 3-way power strip included.



Powerdot Large 09678A067

Complete package for a stylish and functional solution to the conference table. Be supplemented with the desired Powerdot for Ø80 mm holes. 6-way power strip included.



Powerdot MINI - Power 09678A063

For Ø51 mm hole in tabletop. 1 power socket.



Powerdot MINI - USB 09678A064

For Ø51 mm hole in tabletop. 2 USB for charging.



Self-closing braided tube 09678A070

Available in both single and double variant. For mounting under tabletop and seatings.



OCHNO Socket USB-C 09678A076

For Ø18 mm hole in tabletop. Small and smart socket with 3-in-1, charge, communication and docking/video (depends on which head unit). Head unit order separately.



OCHNO Power Conference 09678A069

Type-C based charging and video switch with unique features connecting, up to 4 laptops/mobiles to one screen or projector. Includes 4 buttons for source selection. 2 USB-A for keyboard / mouse. 1 HDMI for monitor/projector, 1 RJ-45 (network). Has Wi-Fi support.



EVENT / PRICE RANGE 01 / Supplier: Gabriel / Fabric width 140 cm / Material: 100% polyester / Weight 420 gr/lm / Abrasion resist.: >100 000 md / Ignitability: BS EN 1021 - 1&2



GAJA CLASSIC / PRICE RANGE 02 / Supplier: Gabriel / Fabric width 140 cm / MtI: 100% worsted / Weight 560 gr/lm / Abrasion resist.: 50 000 md / Ignitability: BS EN 1021-1&2, BS 5852 P2 source 5



FAME / PRICE RANGE 02 / Suppl: Gabriel / Fabric width 140 cm / MtI: 95% wool, 5% polyamide / Weight 730 gr/lm / Abrasion resist.: 200 000 md / Ignitability: EN 1021-P: BS 5852 P 2 crib 5



CRES / PRICE RANGE 02 / Supplier: Vescom / Fabric width 140 cm / Material: 100% Trevira cs / Weight 441 gr/lm / Abrasion resist.: 50 000 md / Ignitability: BS 5852, crib 5



SAMAR / PRICE RANGE 02 / Supplier: Vescom / Fabric width 140 cm / Material: 100% Trevira cs / Weight 660 gr/lm / Abrasion resist.: 50 000 md / Ignitability: BS 5852, crib 5

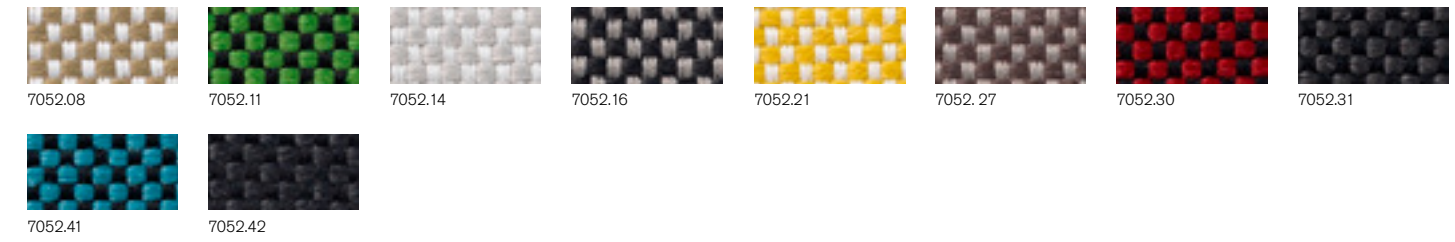

EUROPOST 2 / PRICE RANGE 02 / Supplier: Gabriel / Fabric width 140 cm / Material: 100% virgin wool / Weight 850 gr/lm / Abrasion resist.: 50 000 md / Ignitability: BS EN 1021-P 1&2

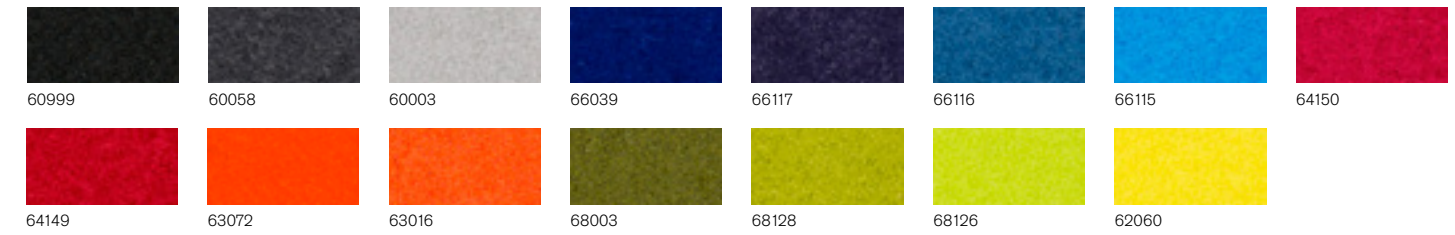

REMIX / PRICE RANGE 03 / Suppl: Kvadrat / Width 135 cm / MtI: 90% wool, 10% nylon / Weight 415 gr/lm / Abrasion resist.: 100 000 md / Ignitability: EN 1021-1/2 ignition source 0-1 BS 5852

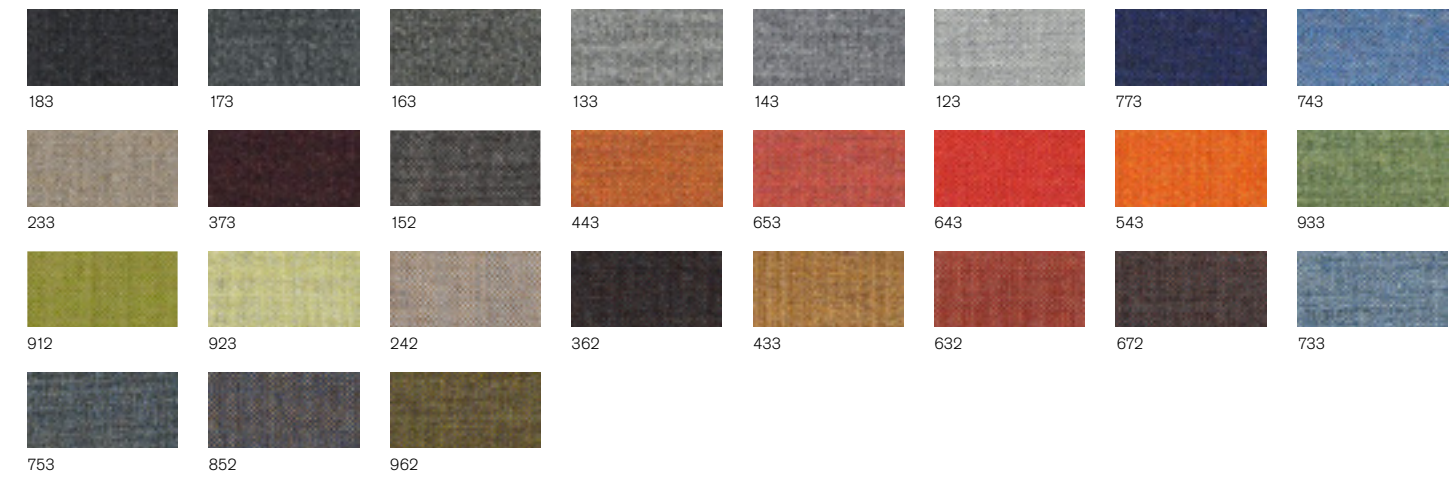

LUNA 2 / PRICE RANGE 03 / Supplier: Gabriel / Fabric width 140 cm / Material: 90% wool, 10% polyamide / Weight 730 gr/lm / Abrasion resist.: 70 000 md / Ignitability: EN 1021 - P 1&2



FABRIC

MESSENGER 4 / PRICE RANGE 03 / Suppl: Kvadrat / Fabric width 137 cm / Mtl: 78% recycled polyester, 15% polyester, 7% nylon / Weight 440 gr/m / Abrasion resist: 65 000 md / Ignitability: Cal. Tech. Bull. 117, Sec E



HALLINGDAL / PRICE RANGE 04 / Supplier: Kvadrat / Fabric width 130 cm / Material: 70% new wool, 30% viscose / Weight 795 gr/m / Abrasion resist: 100 000 md / Ignitability: BS EN 1021 - 1/2

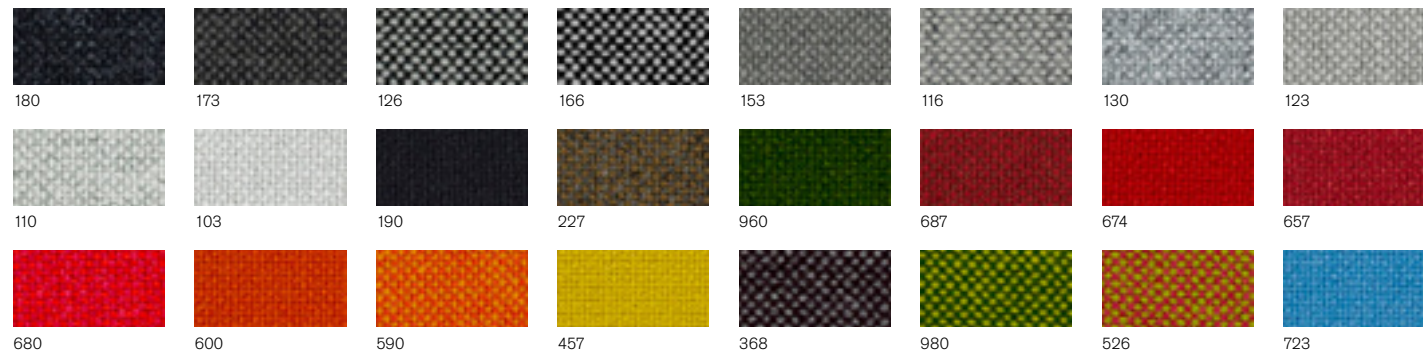

TWEED / PRICE RANGE 04 / Supplier: Bute / Fabric width 140 cm / Material: 100% virgin wool / Weight 645 gr/m / Abrasion resist: 50 000 md / Ignitability: BS EN 1021 - 1 - crib 5



FABRIC

DIVINA MELANGE 3 / PRICE RANGE 04 / Supplier: Kvadrat / Fabric width 150 cm / Material: 100% wool / Weight 840 gr/m / Abrasion resist: 45 000 md / Ignitability: BS 5852, crib 5

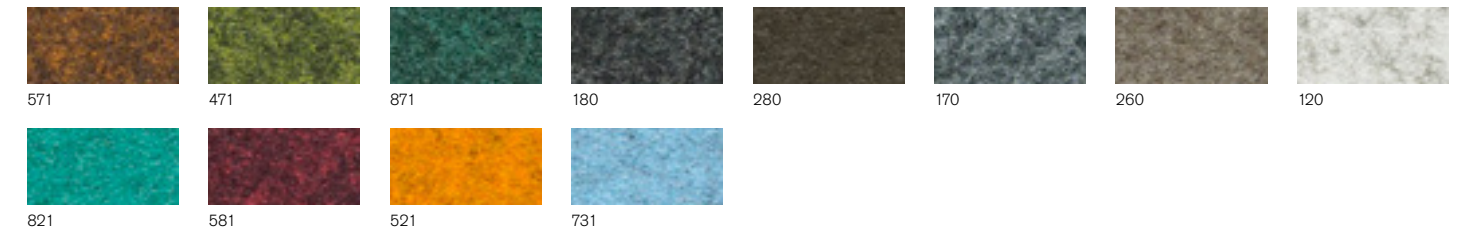

DIVINA MD / PRICE RANGE 04 / Supplier: Kvadrat / Fabric width 150 cm / Material: 100% wool / Weight 840 gr/m / Abrasion resist: 45 000 md / Ignitability: BS 5852, crib 5

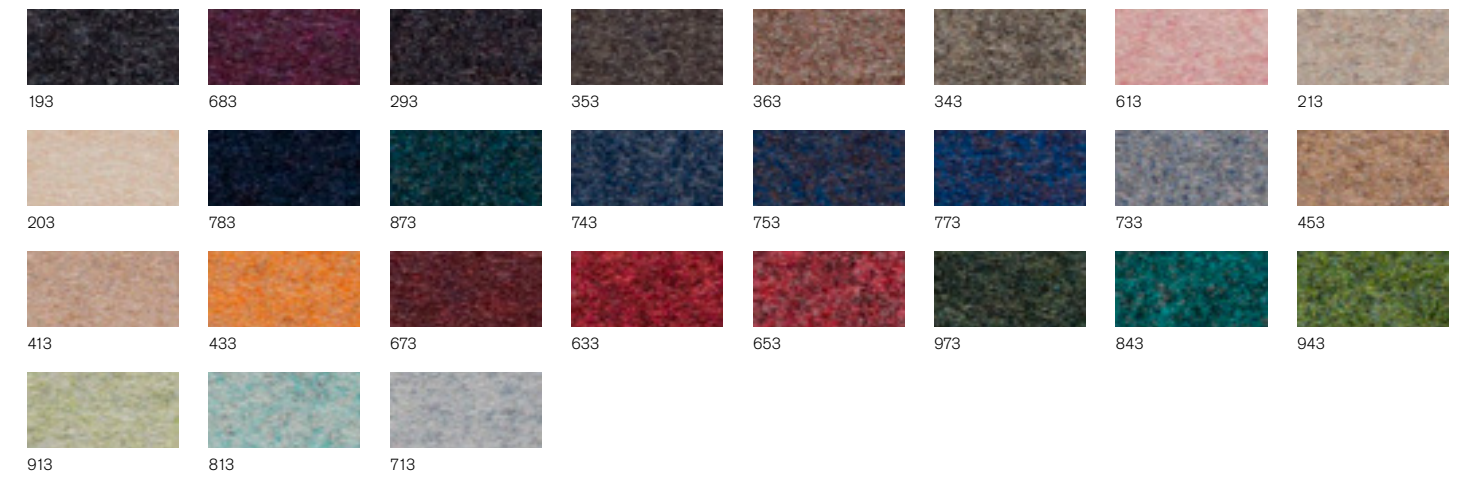

STEELCUT TRIO 3 / PRICE RANGE 04 / Suppl: Kvadrat / Width 140 cm / Mtl: 90% new wool worsted, 10% nylon / Weight 880 gr/m / Abr. resist: 80 000 md / Ignitability: BS 5852, crib 5



LEATHER

ELMOSOFT / Supplier: Elmo / Width ca 5 m² / Material: semi-aniline leather / Weight 700 gr/m²

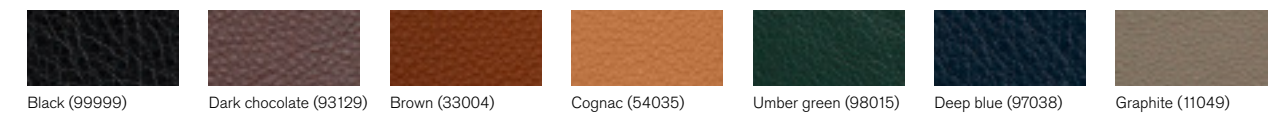

EASE SCREEN FABRIC

EDSBYF FELT / PRICE RANGE 01



BLAZER LITE / PRICE RANGE 02 / Supplier: Camira

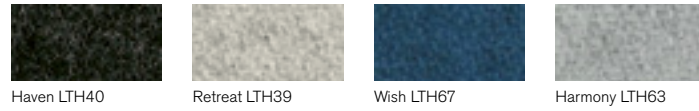

DIVINA MD / PRICE RANGE 03 / Supplier: Kvadrat / Fabric width 150 cm / Material: 100% wool / Weight 840 gr/lm / Abrasion resist: 45 000 md / Ignitability: BS 5852, crib 5



MALTA / PRICE RANGE 03 VINYL (ONLY EASE DESK) / Supplier: Vescom



SCREEN FABRIC

CARLOW / SCREEN FABRIC / Suppl: Camira / Fabric width 170 cm / Mtl: 100% polyolefin / Weight 214 gr/lm / Abrasion resist: 40 000 md / Ignitability: BS EN 1021-1 (cigarette)



CARA / SCREEN FABRIC / Suppl: Camira / Fabric width 170 cm / Mtl: 100% polyolefin / Weight 375 gr/lm / Abrasion resist: 40 000 md / Ignitability: BS476 Part 7 class 1, BS EN 1021-1 (cigarette)



EVENT SCREEN / SCREEN FABRIC / Supplier: Gabriel / Fabric width 170 cm / Material: 100% polyester / Weight 390 gr/lm / Ignitability: BS476 Part 7

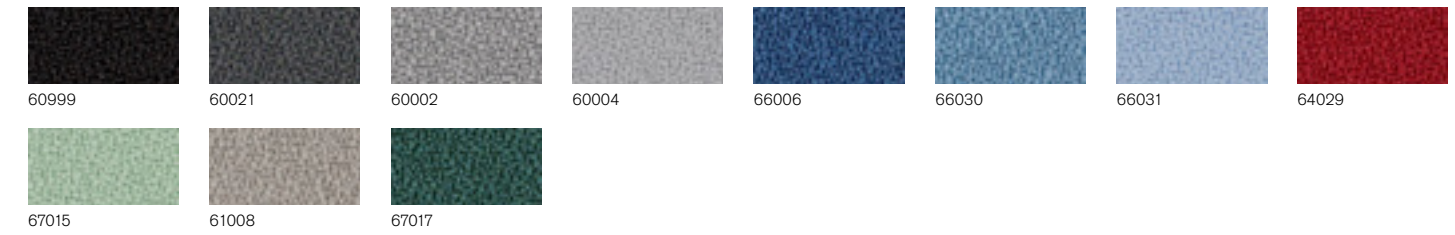

ATLANTIC SCREEN / PRICE RANGE 02 / Supplier: Gabriel / Fabric width 170 cm / Material: 100% polyester / Weight 440 gr/lm / Ignitability: BS476 Part 7



SOUL / PRICE RANGE 02 / Supplier: Gabriel / Fabric width 170 cm / Material: 100% wool / Weight 330 gr/lm / Ignitability: BS476 Part 7

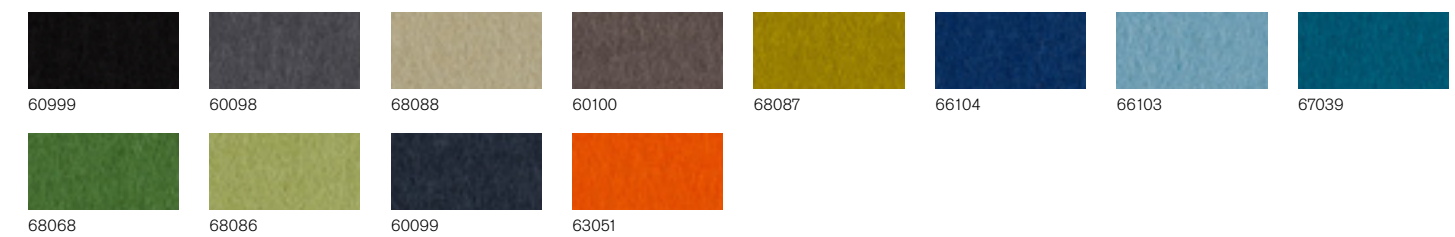

HPL	ALLROUND	CENTRO	CONTINENTAL	ACCESS	COLLEGE	E-POS
White (S 0502-G50Y)						
Light grey (S 2500-N)						
Dark grey (S 6502-B)						
Black (S 9000-N)						

WOOD/VENEER

Birch						
Beech						
Oak						
White glazed ash						

LAMINATE

White laminate						
Light grey laminate						
Birch laminate						
Beech laminate						

LACQUER (STAND/LEGS)

Black lacquer						
White lacquer						
Silver lacquer						
Chrome						

HPL	NEAT	PIECE	FEATHER
White (S 0502-G50Y)			
Light grey (S 2500-N)			
Dark grey (S 6502-B)			
Black (S 9000-N)			

WOOD/VENEER

Birch			
Oak			
Black stained veneer			
White glazed ash			
White stained ash			

DESKTOP

Beige (4176)			
Light grey (4175)			
Black (4023)			

MARBLE

Bianco Carrara			
Verde Guatemala			
Emperador dark			

LACQUER (STAND/LEGS)

Black lacquer			
White lacquer			
Dark Chocolate (8019)			
Misty Grey (7044)			
Silver lacquer			
Chrome			



STORAGE

LACQUER

	NEAT	ACCESS	PART
White (S 0500-N)			
Light grey (S 2500-N)			
Dark grey (S 7000-N)			
Black (S 9000-N)			

WOOD/VENEER

Birch			
Oak			
Black stained veneer			
White glazed ash			
White stained ash			

LAMINATE

White laminate			
Light grey laminate			

MARBLE

Bianco Carrara			
Verde Guatemala			
Emperador dark			

LACQUER (STAND/LEGS)

Black lacquer			
White lacquer			
Dark Chocolate (8019)			
Misty Grey (7044)			
Silver lacquer			
Chrome			

ACCENT COLOUR

White (S 0500-N)	
Light grey (S 2500-N)	
Dark grey (S 7000-N)	
Black (S 9000-N)	
Petroleum (S 7020-B10G)	
Bay leaf green (S 4020-G30Y)	
Fern Green (S 7010-G30Y)	
Sandy Grey (S 2005-Y50R)	



EDSBYN FACTORY

IN THE HEART OF SWEDEN



Furniture production has been our main business since the early start in 1899. The 40.000 sqm large building was completed in 1964 and is together with the head quarter located in Edsbyn, in the heart of Sweden.

In addition to a comprehensive standard range we modify standard products and create customized solutions in close collaboration with our costumers.

A major investment in streamlining the factory flow has been successfully completed in 2019. Edsbyverken is a flexible, automated and streamlined factory.



SUSTAINABILITY

A GUIDING PRINCIPLE

Edsbyn strives to be your natural choice when making furniture selections while considering sustainability and care for the environment. We are constantly working to improve our production processes and carefully select all of the raw materials we use.



CERTIFIED PRODUCTION

Edsbyverken is certified according to quality and environmental management standards: ISO 9001 and ISO 14001.

We expect materials from our suppliers to fulfil the criteria for environmental certification – and we require our suppliers to accept ethical and social responsibility, just like Edsbyn does.



MÖBELFAKTA

CERTIFIED PRODUCTS

Certified according to Möbelfakta means: Technical quality standards for sustainability, stability and safety and for surface resistance. Environmental standards for materials and products. The environmental standards primarily relate to raw materials and components used during manufacture, while the product standards relate to the completed item of furniture.

Producers and subcontractors undertake systematic occupational health and safety work and comply with current occupational health and safety legislation.



NORDIC SWAN ECOLABEL

Edsbyn was the first manufacturer of office furniture to be Nordic Ecolabelled.

Our latest example of a Nordic Ecolabelled product is the Ease screen system which is manufactured from a material normally used for sound absorption in vehicles. It consists of recycled textiles and PET bottles, which makes Ease a good example of sustainable product development.

veneER MATCHING

– NATURAL VARIATIONS IN WOOD



The veneers that Edsbyn uses in its manufacturing derive from natural forests and from sustainable forestry. Each tree is unique, and this produces natural variations in the appearance, structure, and nuance of each veneer.

It is indeed the variation that occurs between different trees and annual rings in the wood that makes veneer products so vibrant and real in its expression.

If you expect a strictly uniform appearance in the products in which you are investing, you should instead opt for a surface made of a material produced in a controlled industrial process, such as a laminate, HPL, or finish-coated surface.

CONTACT EDSBYN



EDSBYN

HQ / Production
AB Edsbyverken
Karls väg 2
SE-828 25 Edsbyn
Tel +46 271-275 00
info@edsbyn.com

RETAILERS

Please visit our website:
edsbyn.com



STOCKHOLM

Showroom
AB Edsbyverken
Hesselmans torg 9
SE-131 34 Nacka
stockholm@edsbyn.com



GÖTEBORG

Showroom
AB Edsbyverken
Fiskhamngatan 6C
SE-414 58 Göteborg
goteborg@edsbyn.com



OSLO

Showroom
AB Edsbyverken
Drammensveien 130C
Inng. B10, 0277 Oslo
oslo@edsbyn.com

DESIGN Edsbyn **PHOTO** Jason Strong, Marias of Sweden, Rasmus Norlander, Klas Sjöberg, Pia Uhlin and others
PRODUCTION Bok & Tryck AB **PRINT** Reklamab

*We reserve the right to make changes to the product range as well as misprints and differences in color rendering.
General Conditions are to be found in separate Pricelist*

